

RESIDENTIAL HVAC WORKSHEET

Owner: _____	Phone #: _____
Address: _____	_____
Contractor: _____	Phone #: _____
Address: _____	_____

SHEET INDEX:

Title Sheet	1
Equipment Location Factor	2
Barrier Shield Factor / Sound Path Factor	3
A-Weighted Sound Pressure Calculation	4

CODES IN EFFECT:

- The 2022 California Title 24 Code of Regulations which include:
- 2022 California Building Code
 - 2022 California Residential Code
 - 2022 California Mechanical Code
 - 2022 California Electrical Code
 - 2022 California Plumbing Code
 - 2022 California Energy Code
 - 2022 California Green Building Standards
 - 2022 California Fire Code
 - City of San Clemente Codes and Ordinances

Standard 275-97 Amended for the City of San Clemente:

**1997
STANDARD for**

**APPLICATION
OF SOUND
RATING
LEVELS OF
OUTDOOR
UNITARY
EQUIPMENT**



Standard 275

Revision 5/1/13

DESCRIPTION OF WORK:

PLACE EXTERIOR MECHANICAL EQUIPMENT HERE:

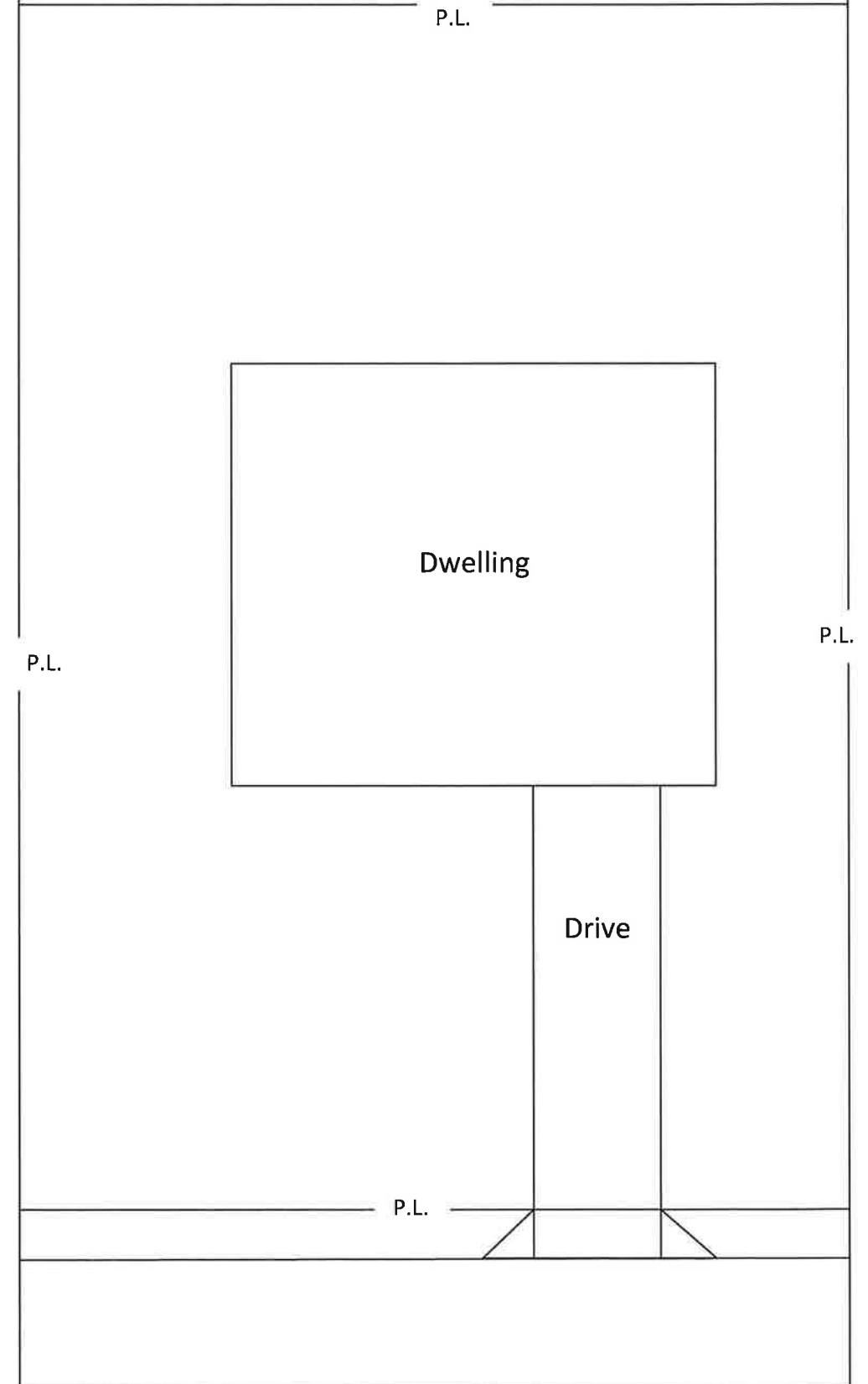

Table 1. Application Factors for Estimating A-Weighted Sound Pressure Levels	
1. Equipment Location Factor	Factor Value
a. Equipment on ground or roof or in side of building wall with <i>no</i> adjacent reflective surface within 10 ft. [3 m] (d greater than 10 ft. [3 m])	0 dB
b. Equipment on ground or roof or in side of building wall with a <i>single</i> adjacent reflective surface within 10 ft. [3 m] (d less than 10 ft. [3 m])	3 dB
	
On Ground or Roof Single Reflective Surface	In Side of Building Single Reflective Surface
c. Equipment on ground or roof or in side of building wall within 10 ft. [3 m] of <i>no</i> adjacent walls forming an inside corner (d less than 10 ft. [3 m] to both surfaces)	6 dB
	
On Ground or Roof Two Adjacent Reflecting Surfaces	In Side of Building Two Adjacent Reflecting Surfaces

Table 1. Application Factors for Estimating A-Weighted Sound Pressure Levels (Continued)	
1. Equipment Location Factor (continued)	Factor Value
d. Equipment on ground or roof or in side of building wall and between two opposite reflecting surface less than 15 ft. [4.6 m] apart	6 dB
	

Table 1. Application Factors for Estimating A-Weighted Sound Pressure Levels (Continued)															
2. Barrier Shielding Factor (see sketches below). Sound reduction benefits can be gained when a solid structure obstructs the sound path. These structures could be:															
<p>Barrier Shielding Factor calculation:</p> <p>$L = L1 - L2$ (L2 also equals "D" direct distance 4.1.4)</p> <p>L1 = _____</p> <p>L2 = _____ (also D 4.1.4)</p> <p>L = _____</p> 															
	<table border="1"> <thead> <tr> <th>L ft. [m]</th> <th>Factor Value</th> </tr> </thead> <tbody> <tr> <td>0.5 [0.15]</td> <td>4 dB</td> </tr> <tr> <td>1 [0.3]</td> <td>7 dB</td> </tr> <tr> <td>2 [0.6]</td> <td>10 dB</td> </tr> <tr> <td>3 [0.9]</td> <td>12 dB</td> </tr> <tr> <td>6 [1.8]</td> <td>15 dB</td> </tr> <tr> <td>12 [3.7]</td> <td>17 dB</td> </tr> </tbody> </table>	L ft. [m]	Factor Value	0.5 [0.15]	4 dB	1 [0.3]	7 dB	2 [0.6]	10 dB	3 [0.9]	12 dB	6 [1.8]	15 dB	12 [3.7]	17 dB
L ft. [m]	Factor Value														
0.5 [0.15]	4 dB														
1 [0.3]	7 dB														
2 [0.6]	10 dB														
3 [0.9]	12 dB														
6 [1.8]	15 dB														
12 [3.7]	17 dB														

Table 1. Application Factors for Estimating A-Weighted Sound Pressure Levels (Continued)	
3. Sound Path Factor	Factor Value
To a point of evaluation outdoors:	0 dB
<p>Excerpt from the City of San Clemente's Municipal Code 8.48.050</p> <p>- Exterior noise standards.</p> <p>The following exterior noise standards, unless otherwise specifically indicated, shall apply to all property within the City. The Land Use category refers to the affected receiver property:</p> <p>Land Use Allowable Exterior Noise Level</p> <p>Residential: 55 dB 7:00 a.m. to 10:00 p.m. 50 dB 10:00 p.m. to 7:00 a.m. (This is the maximum A-weighted sound pressure level allowed found in 4.2 pg.6)</p> <p>Commercial: 65dB 7:00 a.m. to 10:00p.m. 60 dB 10:00pm to 7:00 a.m.</p> <p>Industrial/ manufacturing: 70 dB</p>	

4.1.2 *Barrier Shielding Factor.* This factor accounts for the sound reduction benefit of any solid structure that obstructs the line of sight (or sound) from the equipment location to the point of evaluation. Such a barrier may be the corner of a building, the edge of a roof, or a heavy wall of masonry, etc., built for the specific purpose of shielding noise from a unit to an area of concern. See Item 2, Table 1, for sketches and the normal barrier factors.

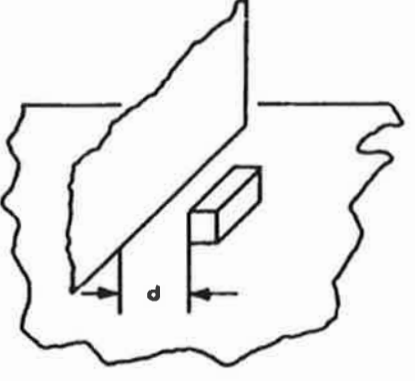
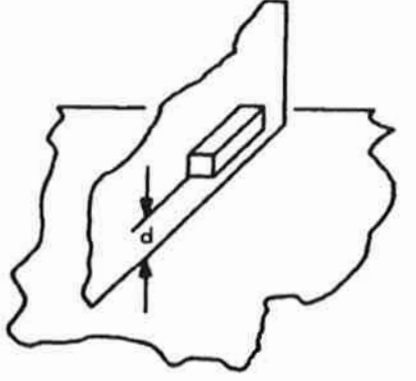
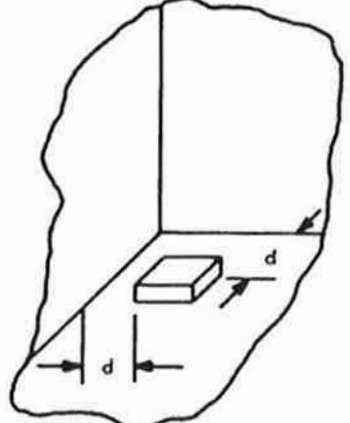
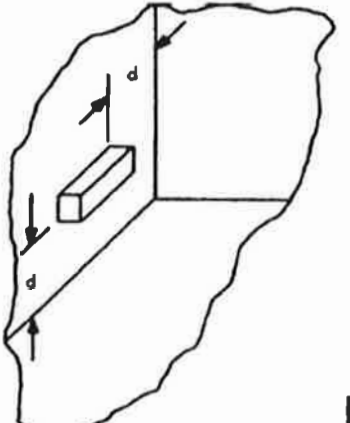
4.1.3 *Sound Path Factor.* This factor adjusts for the path of sound from the unit to the point of evaluation, which may be to the outdoors only, to a room through open windows, to a room through closed windows, or through a wall. See Item 3, Table 1.

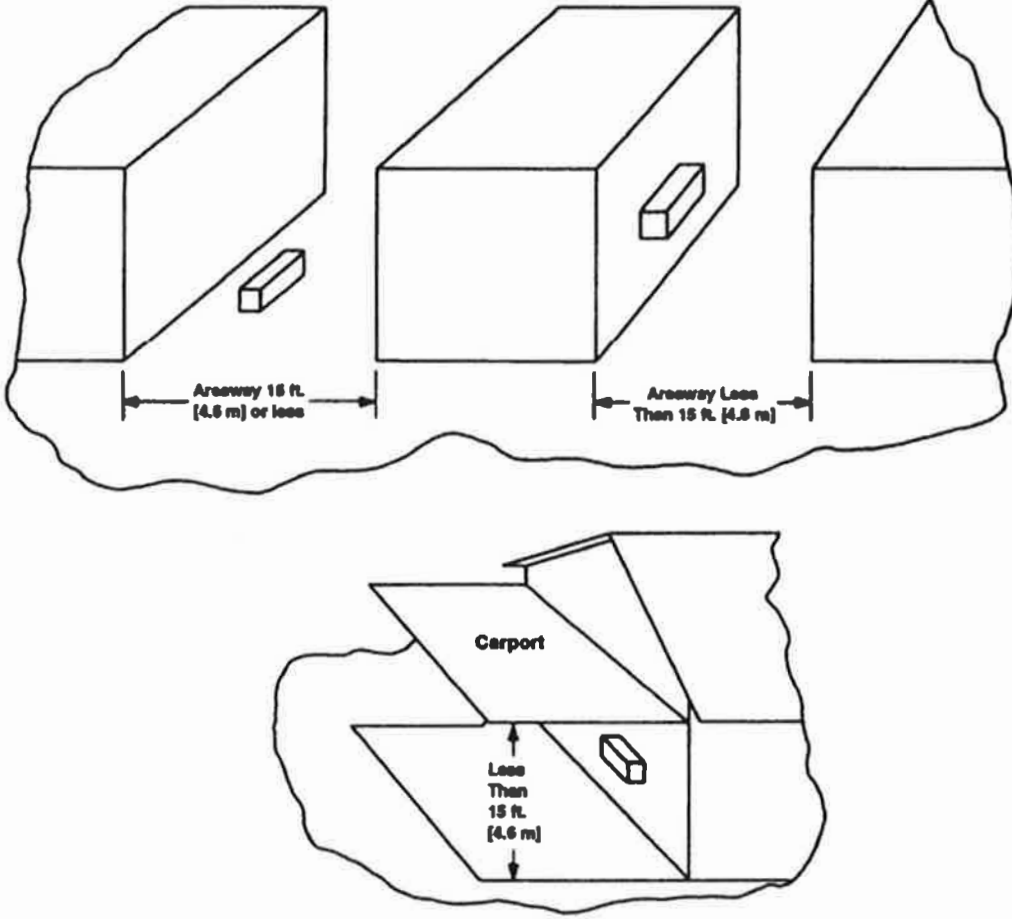
4.1.4 *Distance Factor.* The direct distance, D, from the equipment location to the point of evaluation is a very significant application factor in determining the estimated A-Weighted sound pressure levels resulting from the operation of outdoor equipment in any installation. The distance factor is obtained from Table 2.

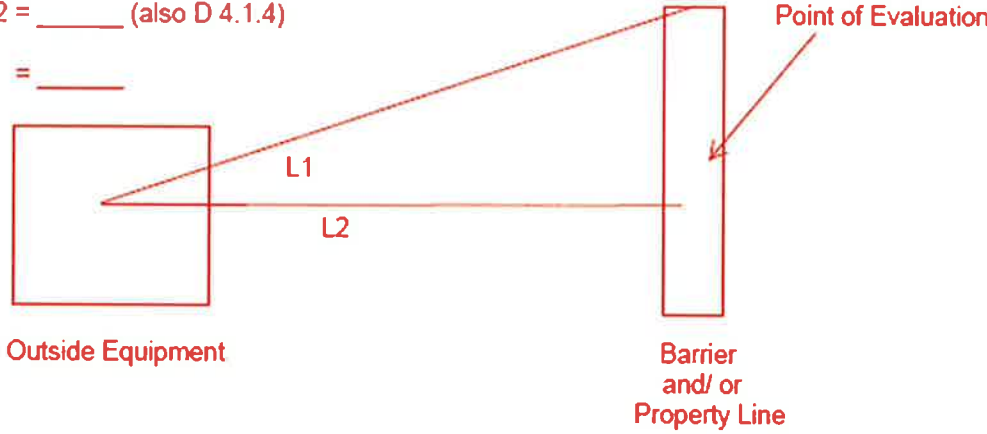
Table 2. Distance Factor		
ft.	[m]	Factor Value (dB)
4	1.2	9.5
5	1.5	11.5
6	1.8	13.0
7	2.1	14.5
8	2.4	15.5
9	2.7	16.5
10	3.0	17.5
15	4.6	21.0
20	6.1	23.5
25	7.6	25.5
30	9.1	27.0
40	12.2	29.5
50	15.2	31.0
60	18.3	33.0
70	21.3	34.5
80	24.4	35.5
90	27.4	36.5
100	30.5	37.5
125	38.1	39.5
150	45.7	41.0
175	53.3	42.5
200	61.0	43.5
400	122.0	49.5

4.2 *Procedure for Estimating Sound Pressure Levels - Single Unit Installation.* The basic procedure for estimating A-Weighted sound pressure levels at a given point of evaluation consists of combining the sum of the application and evaluation factors with the Sound Rating Level for the equipment:

Sound Rating Level from ARI 270	_____
+ Equipment Location Factor	_____
- Barrier Shielding Factor	_____
- Sound Path Factor	_____
- Distance Factor	_____
<hr/>	
Estimated A-Weighted Sound Pressure Level	_____ dB*

4.3 *Procedure for Estimating Sound Levels-Multiple Unit Installation.* Estimated sound levels for multiple unit installations at any point of interest can be determined by combining the effects of each unit at the point of interest. The procedure for multi-unit installations follows that used for single units except for the additional procedure used to combine numbers.

4.3.1 The combined level for all units is determined as follows:

1. Determine the numerical difference between the largest and next largest levels.
2. Using Table 3, find the proper value and add it to the larger number. This combines the two largest numbers.
3. Determine the numerical difference between this combined number and the third largest level. Again, using Table 3, find the proper value and add it to the combined number.
4. Continue this combining procedure until the value to be added from Table 3 becomes 0.0 or until all numbers have been combined.
5. The resulting single number represents the effect of all units at the point of evaluation. (See Example 4.5.4)

Difference Between Numbers (dB)	Value to be Added to Larger Number (dB)
0.0 to 0.5	3.0
1.0 to 1.5	2.5
2.0 to 3.0	2.0
3.5 to 5.0	1.5
5.5 to 7.0	1.0
greater than 7.0	0.0

4.4 *Points of Evaluation.* The calculation procedures described in 4.2 and 4.3 should be made for each area of concern to evaluate the installation from an acoustic standpoint (see 4.5, Examples). Measured A-Weighted sound pressure levels shall be within ± 5 dB of estimated levels when background levels are at least 5 dB below measured values. This estimation error accounts for the effect of the tone adjustment applied during the rating procedure of ARI Standard 270, as well as inaccuracies in the estimation procedure itself. To obtain the background level, readings shall be made with the unit not operating. The effects of environmental conditions on estimated sound levels are not included in this procedure.

* Rounded to the nearest whole dB value.