

**CITY OF SAN CLEMENTE**  
**CONSTRUCTION CONTRACT**

**216 LA CUESTA SEWER REPAIR AND MANHOLE CONSTRUCTION**

**1. PARTIES AND DATE.**

This Contract is made and entered into this 20 day of September 2022 by and between the City of San Clemente, a public agency of the State of California ("City") and Ferreira (DBA Ferreira Coastal Construction Co.), with its principal place of business at 10370 Commerce Center Drive Suite B-200 Rancho Cucamonga, CA 91730 ("Contractor"). City and Contractor are sometimes individually referred to as "Party" and collectively as "Parties" in this Contract.

**2. RECITALS.**

2.1 City. City is a public agency organized under the laws of the State of California, with power to contract for services necessary to achieve its purpose.

2.2 Contractor. Contractor desires to perform and assume responsibility for the provision of certain construction services required by the City on the terms and conditions set forth in this Contract. Contractor represents that it is duly licensed and experienced in providing Sewer Pipeline and Manhole Services related construction services to public clients, that it and its employees or subcontractors have all necessary licenses and permits to perform the services in the State of California, and that it is familiar with the plans of City. The following license classifications are required for this Project: California Contractor License "A".

2.3 Project. City desires to engage Contractor to render such services for the 216 La Cuesta Sewer Repair and Manhole Construction Project ("Project") as set forth in this Contract.

2.4 Project Documents & Certifications. Contractor has obtained, and delivers concurrently herewith, a performance bond, a payment bond, and all insurance documentation, as required by the Contract.

**3. TERMS**

3.1 Incorporation of Documents. This Contract includes and hereby incorporates in full by reference the following documents, including all exhibits, drawings, specifications and documents therein, and attachments and addenda thereto:

- Services/Schedule (Exhibit "A")
- Plans and Specifications (Exhibit "B") *NONE ATTACHED*
- Special Conditions (Exhibit "C")
- Contractor's Certificate Regarding Workers' Compensation (Exhibit "D")
- Public Works Contractor Registration Certification (Exhibit "E")
- Payment and Performance Bonds (Exhibit "F")
- Federal Requirements (Exhibit "G")
- Insurance Requirements (Exhibit "H")
- Addenda
- Change Orders executed by the City

- 2018 Edition of the Standard Specifications for Public Works Construction (The Greenbook), Excluding Sections 1-9
- Notice Inviting Bids, if any
- Instructions to Bidders, if any
- Contractor's Bid

3.2 Contractor's Basic Obligation; Scope of Work. Contractor promises and agrees, at its own cost and expense, to furnish to the City all labor, materials, tools, equipment, services, and incidental and customary work necessary to fully and adequately complete the Project, including all structures and facilities necessary for the Project or described in the Contract (hereinafter sometimes referred to as the "Work"), for a Total Contract Price as specified pursuant to this Contract. All Work shall be subject to, and performed in accordance with the above referenced documents, as well as the exhibits attached hereto and incorporated herein by reference. The plans and specifications for the Work are further described in Exhibit "B" attached hereto and incorporated herein by this reference. Special Conditions, if any, relating to the Work are described in Exhibit "C" attached hereto and incorporated herein by this reference.

3.2.1 Change in Scope of Work. Any change in the scope of the Work, method of performance, nature of materials or price thereof, or any other matter materially affecting the performance or nature of the Work shall not be paid for or accepted unless such change, addition or deletion is approved in writing by a valid change order executed by the City. Should Contractor request a change order due to unforeseen circumstances affecting the performance of the Work, such request shall be made within five (5) business days of the date such circumstances are discovered or shall waive its right to request a change order due to such circumstances. If the Parties cannot agree on any change in price required by such change in the Work, the City may direct the Contractor to proceed with the performance of the change on a time and materials basis.

3.2.2 Substitutions/"Or Equal". Pursuant to Public Contract Code Section 3400(b), the City may make a finding that designates certain products, things, or services by specific brand or trade name. Unless specifically designated in this Contract, whenever any material, process, or article is indicated or specified by grade, patent, or proprietary name or by name of manufacturer, such Specifications shall be deemed to be used for the purpose of facilitating the description of the material, process or article desired and shall be deemed to be followed by the words "or equal."

Contractor may, unless otherwise stated, offer for substitution any material, process or article which shall be substantially equal or better in every respect to that so indicated or specified in this Contract. However, the City may have adopted certain uniform standards for certain materials, processes and articles. Contractor shall submit requests, together with substantiating data, for substitution of any "or equal" material, process or article no later than thirty-five (35) days after award of the Contract. To facilitate the construction schedule and sequencing, some requests may need to be submitted before thirty-five (35) days after award of Contract. Provisions regarding submission of "or equal" requests shall not in any way authorize an extension of time for performance of this Contract. If a proposed "or equal" substitution request is rejected, Contractor shall be responsible for providing the specified material, process or article. The burden of proof as to the equality of any material, process or article shall rest with Contractor.

The City has the complete and sole discretion to determine if a material, process or article is an "or equal" material, process or article that may be substituted. Data required to substantiate requests for substitutions of an "or equal" material, process or article shall

include a signed affidavit from Contractor stating that, and describing how, the substituted "or equal" material, process or article is equivalent to that specified in every way except as listed on the affidavit. Substantiating data shall include any and all illustrations, specifications, and other relevant data including catalog information which describes the requested substituted "or equal" material, process or article, and substantiates that it is an "or equal" to the material, process or article. The substantiating data must also include information regarding the durability and lifecycle cost of the requested substituted "or equal" material, process or article. Failure to submit all the required substantiating data, including the signed affidavit, to the City in a timely fashion will result in the rejection of the proposed substitution.

Contractor shall bear all of the City's costs associated with the review of substitution requests. Contractor shall be responsible for all costs related to a substituted "or equal" material, process or article. Contractor is directed to the Special Conditions (if any) to review any findings made pursuant to Public Contract Code section 3400.

### 3.3 Period of Performance.

3.3.1 Contract Time. Contractor shall perform and complete all Work under this Contract within Thirty (30) Working Days, beginning the effective date of the Notice to Proceed ("Contract Time"). Contractor shall perform its Work in strict accordance with any completion schedule, construction schedule or project milestones developed by the City. Such schedules or milestones may be included as part of Exhibits "A" or "B" attached hereto, or may be provided separately in writing to Contractor. Contractor agrees that if such Work is not completed within the aforementioned Contract Time and/or pursuant to any such completion schedule, construction schedule or project milestones developed pursuant to provisions of the Contract, it is understood, acknowledged and agreed that the City will suffer damage.

3.3.2 Force Majeure. Neither City nor Contractor shall be considered in default of this Contract for delays in performance caused by circumstances beyond the reasonable control of the non-performing party. For purposes of this Contract, such circumstances include but are not limited to, abnormal weather conditions; floods; earthquakes; fire; pandemics or epidemics; war; riots and other civil disturbances; strikes, lockouts, work slowdowns, and other labor disturbances; sabotage or judicial restraint. Should such circumstances occur, the non-performing party shall, within a reasonable time of being prevented from performing, give written notice to the other party describing the circumstances preventing continued performance and the efforts being made to resume performance of this Contract. Contractor's exclusive remedy in the event of delay covered under this section shall be a non-compensable extension of the Contract Time.

3.3.3 Liquidated Damages. Pursuant to Government Code Section 53069.85, Contractor shall pay to the City as fixed and liquidated damages the sum of Eight Hundred Dollars (\$800) per day for each and every calendar day of delay beyond the Contract Time or beyond any completion schedule, construction schedule or Project milestones established pursuant to the Contract.

3.4 Standard of Performance; Performance of Employees. Contractor shall perform all Work under this Contract in a skillful and workmanlike manner, and consistent with the standards generally recognized as being employed by professionals in the same discipline in the State of California. Contractor represents and maintains that it is skilled in the professional calling necessary to perform the Work. Contractor warrants that all employees and subcontractors shall have sufficient skill and experience to perform the Work assigned to them. Finally, Contractor

represents that it, its employees and subcontractors have all licenses, permits, qualifications and approvals of whatever nature that are legally required to perform the Work, including any required business license, and that such licenses and approvals shall be maintained throughout the term of this Contract. As provided for in the indemnification provisions of this Contract, Contractor shall perform, at its own cost and expense and without reimbursement from the City, any work necessary to correct errors or omissions which are caused by Contractor's failure to comply with the standard of care provided for herein. Any employee who is determined by the City to be uncooperative, incompetent, a threat to the safety of persons or the Work, or any employee who fails or refuses to perform the Work in a manner acceptable to the City, shall be promptly removed from the Project by Contractor and shall not be re-employed on the Work.

3.5 Control and Payment of Subordinates; Contractual Relationship. City retains Contractor on an independent contractor basis and Contractor is not an employee of City. Any additional personnel performing the work governed by this Contract on behalf of Contractor shall at all times be under Contractor's exclusive direction and control. Contractor shall pay all wages, salaries, and other amounts due such personnel in connection with their performance under this Contract and as required by law. Contractor shall be responsible for all reports and obligations respecting such additional personnel, including, but not limited to: social security taxes, income tax withholding, unemployment insurance, and workers' compensation insurance.

3.6 City's Basic Obligation. City agrees to engage and does hereby engage Contractor as an independent contractor to furnish all materials and to perform all Work according to the terms and conditions herein contained for the sum set forth above. Except as otherwise provided in the Contract, the City shall pay to Contractor, as full consideration for the satisfactory performance by Contractor of the services and obligations required by this Contract, the below-referenced compensation in accordance with compensation provisions set forth in the Contract.

3.7 Compensation and Payment.

3.7.1 Amount of Compensation. As consideration for performance of the Work required herein, City agrees to pay Contractor the Total Contract Price of Forty Three Thousand, One Hundred Ninety-Nine Dollars and Two Cents (\$43,199.02) ("Total Contract Price") provided that such amount shall be subject to adjustment pursuant to the applicable terms of this Contract or written change orders approved and signed in advance by the City.

3.7.2 Payment of Compensation. If the Work is scheduled for completion in thirty (30) or less calendar days, City will arrange for payment of the Total Contract Price upon completion and approval by City of the Work. If the Work is scheduled for completion in more than thirty (30) calendar days, City will pay Contractor on a monthly basis as provided for herein. On or before the fifth (5th) day of each month, Contractor shall submit to the City an itemized application for payment in the format supplied by the City indicating the amount of Work completed since commencement of the Work or since the last progress payment. These applications shall be supported by evidence which is required by this Contract and such other documentation as the City may require. The Contractor shall certify that the Work for which payment is requested has been done and that the materials listed are stored where indicated. Contractor may be required to furnish a detailed schedule of values upon request of the City and in such detail and form as the City shall request, showing the quantities, unit prices, overhead, profit, and all other expenses involved in order to provide a basis for determining the amount of progress payments.

3.7.3 Prompt Payment. City shall review and pay all progress payment requests in accordance with the provisions set forth in Section 20104.50 of the California Public Contract

Code. However, no progress payments will be made for Work not completed in accordance with this Contract. Contractor shall comply with all applicable laws, rules and regulations relating to the proper payment of its employees, subcontractors, suppliers or others.

3.7.4 Contract Retentions. From each approved progress estimate, five percent (5%) will be deducted and retained by the City, and the remainder will be paid to Contractor. All Contract retention shall be released and paid to Contractor and subcontractors pursuant to California Public Contract Code Section 7107.

3.7.5 Other Retentions. In addition to Contract retentions, the City may deduct from each progress payment an amount necessary to protect City from loss because of: (1) liquidated damages which have accrued as of the date of the application for payment; (2) any sums expended by the City in performing any of Contractor's obligations under the Contract which Contractor has failed to perform or has performed inadequately; (3) defective Work not remedied; (4) stop notices as allowed by state law; (5) reasonable doubt that the Work can be completed for the unpaid balance of the Total Contract Price or within the scheduled completion date; (6) unsatisfactory prosecution of the Work by Contractor; (7) unauthorized deviations from the Contract; (8) failure of Contractor to maintain or submit on a timely basis proper and sufficient documentation as required by the Contract or by City during the prosecution of the Work; (9) erroneous or false estimates by Contractor of the value of the Work performed; (10) any sums representing expenses, losses, or damages as determined by the City, incurred by the City for which Contractor is liable under the Contract; and (11) any other sums which the City is entitled to recover from Contractor under the terms of the Contract or pursuant to state law, including Section 1727 of the California Labor Code. The failure by the City to deduct any of these sums from a progress payment shall not constitute a waiver of the City's right to such sums.

3.7.6 Substitutions for Contract Retentions. In accordance with California Public Contract Code Section 22300, the City will permit the substitution of securities for any monies withheld by the City to ensure performance under the Contract. At the request and expense of Contractor, securities equivalent to the amount withheld shall be deposited with the City, or with a state or federally chartered bank in California as the escrow agent, and thereafter the City shall then pay such monies to Contractor as they come due. Upon satisfactory completion of the Contract, the securities shall be returned to Contractor. For purposes of this Section and Section 22300 of the Public Contract Code, the term "satisfactory completion of the contract" shall mean the time the City has issued written final acceptance of the Work and filed a Notice of Completion as required by law and provisions of this Contract. Contractor shall be the beneficial owner of any securities substituted for monies withheld and shall receive any interest thereon. The escrow agreement used for the purposes of this Section shall be in the form provided by the City.

3.7.7 Title to Work. As security for partial, progress, or other payments, title to Work for which such payments are made shall pass to the City at the time of payment. To the extent that title has not previously been vested in the City by reason of payments, full title shall pass to the City at delivery of the Work at the destination and time specified in this Contract. Such transferred title shall in each case be good, free and clear from any and all security interests, liens, or other encumbrances. Contractor promises and agrees that it will not pledge, hypothecate, or otherwise encumber the items in any manner that would result in any lien, security interest, charge, or claim upon or against said items. Such transfer of title shall not imply acceptance by the City, nor relieve Contractor from the responsibility to strictly comply with the Contract, and shall not relieve Contractor of responsibility for any loss of or damage to items.

3.7.8 Labor and Material Releases. Contractor shall furnish City with labor and material releases from all subcontractors performing work on, or furnishing materials for, the Work governed by this Contract prior to final payment by City.

3.7.9 Prevailing Wages. Contractor is aware of the requirements of California Labor Code Section 1720 et seq., and 1770 et seq., as well as California Code of Regulations, Title 8, Section 16000 et seq., ("Prevailing Wage Laws"), which require the payment of prevailing wage rates and the performance of other requirements on "public works" and "maintenance" projects. Since the Services are being performed as part of an applicable "public works" or "maintenance" project, as defined by the Prevailing Wage Laws, and since the total compensation is \$1,000 or more, Contractor agrees to fully comply with such Prevailing Wage Laws. City shall provide Contractor with a copy of the prevailing rates of per diem wages in effect at the commencement of this Contract upon request. Contractor shall make copies of the prevailing rates of per diem wages for each craft, classification or type of worker needed to execute the Services available to interested parties upon request, and shall post copies at Contractor's principal place of business and at the project site. Contractor shall defend, indemnify and hold the City, its officials, officers, employees and agents free and harmless from any claim or liability arising out of any failure or alleged failure to comply with the Prevailing Wage Laws. Contractor and any subcontractor shall forfeit a penalty of up to \$200 per calendar day or portion thereof for each worker paid less than the prevailing wage rates.

3.7.10 Apprenticeable Crafts. When Contractor employs workmen in an apprenticeable craft or trade, Contractor shall comply with the provisions of Section 1777.5 of the California Labor Code with respect to the employment of properly registered apprentices upon public works. The primary responsibility for compliance with said section for all apprenticeable occupations shall be with Contractor. The Contractor or any subcontractor that is determined by the Labor Commissioner to have knowingly violated Section 1777.5 shall forfeit as a civil penalty an amount not exceeding \$100 for each full calendar day of noncompliance, or such greater amount as provided by law.

3.7.11 Hours of Work. Contractor is advised that eight (8) hours labor constitutes a legal day's work. Pursuant to Section 1813 of the California Labor Code, Contractor shall forfeit a penalty of \$25.00 per worker for each day that each worker is permitted to work more than eight (8) hours in any one calendar day and forty (40) hours in any one calendar week, except when payment for overtime is made at not less than one and one-half (1-1/2) times the basic rate for that worker.

3.7.12 Payroll Records. Contractor and each subcontractor shall keep an accurate payroll record, showing the name, address, social security number, work classification, straight time and overtime hours worked each day and week, and the actual per diem wages paid to each journeyman, apprentice, worker, or other employee employed by him or her in connection with the public work. The payroll records shall be certified and shall be available for inspection at all reasonable hours at the principal office of Contractor in the manner provided in Labor Code section 1776. In the event of noncompliance with the requirements of this section, Contractor shall have 10 days in which to comply subsequent to receipt of written notice specifying in what respects such Contractor must comply with this section. Should noncompliance still be evident after such 10-day period, Contractor shall, as a penalty to City, forfeit not more than \$100.00 for each calendar day or portion thereof, for each worker, until strict compliance is effectuated. The amount of the forfeiture is to be determined by the Labor Commissioner. A contractor who is found to have violated the provisions of law regarding wages on Public Works with the intent to defraud shall be ineligible to bid on Public Works contracts for a period of one to three years as



determined by the Labor Commissioner. Upon the request of the Division of Apprenticeship Standards or the Division of Labor Standards Enforcement, such penalties shall be withheld from progress payments then due. The responsibility for compliance with this section is on Contractor. The requirement to submit certified payroll records directly to the Labor Commissioner under Labor Code section 1771.4 shall not apply to work performed on a public works project that is exempt pursuant to the small project exemption specified in Labor Code Section 1771.4.

3.7.13 Contractor and Subcontractor Registration. Pursuant to Labor Code sections 1725.5 and 1771.1, all contractors and subcontractors that wish to bid on, be listed in a bid proposal, or enter into a contract to perform public work must be registered with the Department of Industrial Relations. No bid will be accepted nor any contract entered into without proof of the contractor's and subcontractors' current registration with the Department of Industrial Relations to perform public work. Contractor is directed to review, fill out and execute the Public Works Contractor Registration Certification attached hereto as Exhibit "E" prior to contract execution. Notwithstanding the foregoing, the contractor registration requirements mandated by Labor Code Sections 1725.5 and 1771.1 shall not apply to work performed on a public works project that is exempt pursuant to the small project exemption specified in Labor Code Sections 1725.5 and 1771.1.

3.7.14 Labor Compliance; Stop Orders. This Project is subject to compliance monitoring and enforcement by the Department of Industrial Relations. It shall be the Contractor's sole responsibility to evaluate and pay the cost of complying with all labor compliance requirements under this Contract and applicable law. Any stop orders issued by the Department of Industrial Relations against Contractor or any subcontractor that affect Contractor's performance of Work, including any delay, shall be Contractor's sole responsibility. Any delay arising out of or resulting from such stop orders shall be considered Contractor caused delay subject to any applicable liquidated damages and shall not be compensable by the City. Contractor shall defend, indemnify and hold the City, its officials, officers, employees and agents free and harmless from any claim or liability arising out of stop orders issued by the Department of Industrial Relations against Contractor or any subcontractor.

### 3.8 Performance of Work; Jobsite Obligations.

#### 3.8.1 Water Quality Management and Compliance.

3.8.1.1 Water Quality Management and Compliance. Contractor shall keep itself and all subcontractors, staff, and employees fully informed of and in compliance with all local, state and federal laws, rules and regulations that may impact, or be implicated by the performance of the Work including, without limitation, all applicable provisions of the Federal Water Pollution Control Act (33 U.S.C. §§ 1300); the California Porter-Cologne Water Quality Control Act (Cal Water Code §§ 13000-14950); local ordinances regulating discharges of storm water; and any and all regulations, policies, or permits issued pursuant to any such authority regulating the discharge of pollutants, as that term is used in the Porter-Cologne Water Quality Control Act, to any ground or surface water in the State.

3.8.1.2 Compliance with the Statewide Construction General Permit. Contractor shall comply with all conditions of the most recent iteration of the National Pollutant Discharge Elimination System General Permit for Storm Water Discharges Associated with Construction Activity, issued by the California State Water Resources Control Board ("Permit"). It shall be Contractor's sole responsibility to file a Notice of Intent and procure coverage under the Permit for all construction activity which results in the disturbance of more than one

acre of total land area or which is part of a larger common area of development or sale. Prior to initiating work, Contractor shall be solely responsible for preparing and implementing a Storm Water Pollution Prevention Plan (SWPPP) as required by the Permit. Contractor shall be responsible for procuring, implementing and complying with the provisions of the Permit and the SWPPP, including the standard provisions, and monitoring and reporting requirements as required by the Permit. The Permit requires the SWPPP to be a "living document" that changes as necessary to meet the conditions and requirements of the job site as it progresses through different phases of construction and is subject to different weather conditions. It shall be Contractor's sole responsibility to update the SWPPP as necessary to address conditions at the project site.

3.8.1.3 Other Water Quality Rules Regulations and Policies. Contractor shall comply with the lawful requirements of any applicable municipality, drainage City, or local agency regarding discharges of storm water to separate storm drain systems or other watercourses under their jurisdiction, including applicable requirements in municipal storm water management programs.

3.8.1.4 Cost of Compliance. Storm, surface, nuisance, or other waters may be encountered at various times during construction of The Work. Therefore, the Contractor, by submitting a Bid, hereby acknowledges that it has investigated the risk arising from such waters, has prepared its Bid accordingly, and assumes any and all risks and liabilities arising therefrom.

3.8.1.5 Liability for Non-Compliance. Failure to comply with the Permit is a violation of federal and state law. Pursuant to the indemnification provisions of this Contract, Contractor hereby agrees to defend, indemnify and hold harmless the City and its officials, officers, employees, volunteers and agents for any alleged violations. In addition, City may seek damages from Contractor for any delay in completing the Work in accordance with the Contract, if such delay is caused by or related to Contractor's failure to comply with the Permit.

3.8.1.6 Reservation of Right to Defend. City reserves the right to defend any enforcement action brought against the City for Contractor's failure to comply with the Permit or any other relevant water quality law, regulation, or policy. Pursuant to the indemnification provisions of this Contract, Contractor hereby agrees to be bound by, and to reimburse the City for the costs (including the City's attorney's fees) associated with, any settlement reached between the City and the relevant enforcement entity.

3.8.1.7 Training. In addition to the standard of performance requirements set forth in paragraph 3.4, Contractor warrants that all employees and subcontractors shall have sufficient skill and experience to perform the Work assigned to them without impacting water quality in violation of the laws, regulations and policies described in paragraph 3.8.1. Contractor further warrants that it, its employees and subcontractors will receive adequate training, as determined by City, regarding the requirements of the laws, regulations and policies described in paragraph 3.8.1 as they may relate to the Work provided under this Agreement. Upon request, City will provide the Contractor with a list of training programs that meet the requirements of this paragraph.

3.8.2 Safety. Contractor shall execute and maintain its work so as to avoid injury or damage to any person or property. Contractor shall comply with the requirements of the specifications relating to safety measures applicable in particular operations or kinds of work. In carrying out its Work, Contractor shall at all times be in compliance with all applicable local, state



and federal laws, rules and regulations, and shall exercise all necessary precautions for the safety of employees appropriate to the nature of the Work and the conditions under which the Work is to be performed. Safety precautions as applicable shall include, but shall not be limited to, adequate life protection and lifesaving equipment; adequate illumination for underground and night operations; instructions in accident prevention for all employees, such as machinery guards, safe walkways, scaffolds, ladders, bridges, gang planks, confined space procedures, trenching and shoring, fall protection and other safety devices, equipment and wearing apparel as are necessary or lawfully required to prevent accidents or injuries; and adequate facilities for the proper inspection and maintenance of all safety measures. Furthermore, Contractor shall prominently display the names and telephone numbers of at least two medical doctors practicing in the vicinity of the Project, as well as the telephone number of the local ambulance service, adjacent to all telephones at the Project site.

3.8.3 Laws and Regulations. Contractor shall keep itself fully informed of and in compliance with all local, state and federal laws, rules and regulations in any manner affecting the performance of the Contract or the Work, including all Cal/OSHA requirements, and shall give all notices required by law. Contractor shall be liable for all violations of such laws and regulations in connection with Work. If Contractor observes that the drawings or specifications are at variance with any law, rule or regulation, it shall promptly notify the City in writing. Any necessary changes shall be made by written change order. If Contractor performs any work knowing it to be contrary to such laws, rules and regulations and without giving written notice to the City, Contractor shall be solely responsible for all costs arising therefrom. City is a public entity of the State of California subject to certain provisions of the Health & Safety Code, Government Code, Public Contract Code, and Labor Code of the State. It is stipulated and agreed that all provisions of the law applicable to the public contracts of a municipality are a part of this Contract to the same extent as though set forth herein and will be complied with. Contractor shall defend, indemnify and hold City, its officials, officers, employees and agents free and harmless, pursuant to the indemnification provisions of this Contract, from any claim or liability arising out of any failure or alleged failure to comply with such laws, rules or regulations.

3.8.4 Permits and Licenses. Contractor shall be responsible for securing City permits and licenses necessary to perform the Work described herein, including, but not limited to, any required business license. While Contractor will not be charged a fee for any City permits, Contractor shall pay the City's business license fee, if any. Any ineligible contractor or subcontractor pursuant to Labor Code Sections 1777.1 and 1777.7 may not perform work on this Project.

3.8.5 Trenching Work. If the Total Contract Price exceeds \$25,000 and if the Work governed by this Contract entails excavation of any trench or trenches five (5) feet or more in depth, Contractor shall comply with all applicable provisions of the California Labor Code, including Section 6705. To this end, Contractor shall submit for City's review and approval a detailed plan showing the design of shoring, bracing, sloping, or other provisions to be made for worker protection from the hazard of caving ground during the excavation of such trench or trenches. If such plan varies from the shoring system standards, the plan shall be prepared by a registered civil or structural engineer.

3.8.6 Hazardous Materials and Differing Conditions. As required by California Public Contract Code Section 7104, if this Contract involves digging trenches or other excavations that extend deeper than four (4) feet below the surface, Contractor shall promptly, and prior to disturbance of any conditions, notify City of: (1) any material discovered in excavation that Contractor believes to be a hazardous waste that is required to be removed to a Class I, Class II

or Class III disposal site; (2) subsurface or latent physical conditions at the site differing from those indicated by City; and (3) unknown physical conditions of an unusual nature at the site, significantly different from those ordinarily encountered in such contract work. Upon notification, City shall promptly investigate the conditions to determine whether a change order is appropriate. In the event of a dispute, Contractor shall not be excused from any scheduled completion date and shall proceed with all Work to be performed under the Contract, but shall retain all rights provided by the Contract or by law for making protests and resolving the dispute.

**3.8.7 Underground Utility Facilities.** To the extent required by Section 4215 of the California Government Code, City shall compensate Contractor for the costs of: (1) locating and repairing damage to underground utility facilities not caused by the failure of Contractor to exercise reasonable care; (2) removing or relocating underground utility facilities not indicated in the construction drawings; and (3) equipment necessarily idled during such work. Contractor shall not be assessed liquidated damages for delay caused by failure of City to provide for removal or relocation of such utility facilities.

**3.8.8 Air Quality.** Contractor must fully comply with all applicable laws, rules and regulations in furnishing or using equipment and/or providing services, including, but not limited to, emissions limits and permitting requirements imposed by the California Air Resources Board (CARB). Although CARB limits and requirements are more broad, Contractor shall specifically be aware of their application to "portable equipment", which definition is considered by CARB to include any item of equipment with a fuel-powered engine. Contractor shall indemnify City against any fines or penalties imposed by CARB, or any other governmental or regulatory agency for violations of applicable laws, rules and/or regulations by Contractor, its subcontractors, or others for whom Contractor is responsible under its indemnity obligations provided for in this Agreement.

**3.8.9 State Recycling Mandates.** Contractor shall comply with State Recycling Mandates. Any recyclable materials/debris collected by the contractor that can be feasibly diverted via reuse or recycling must be hauled by the appropriate handler for reuse or recycling.

**3.9 Completion of Work.** When Contractor determines that it has completed the Work required herein, Contractor shall so notify City in writing and shall furnish all labor and material releases required by this Contract. City shall thereupon inspect the Work. If the Work is not acceptable to the City, the City shall indicate to Contractor in writing the specific portions or items of Work which are unsatisfactory or incomplete. Once Contractor determines that it has completed the incomplete or unsatisfactory Work, Contractor may request a reinspection by the City. Once the Work is acceptable to City, City shall pay to Contractor the Total Contract Price remaining to be paid, less any amount which City may be authorized or directed by law to retain. Payment of retention proceeds due to Contractor shall be made in accordance with Section 7107 of the California Public Contract Code.

**3.10 Claims; Government Code Claim Compliance.**

**3.10.1 Intent.** Effective January 1, 1991, Section 20104 et seq., of the California Public Contract Code prescribes a process utilizing informal conferences, non-binding judicial supervised mediation, and judicial arbitration to resolve disputes on construction claims of \$375,000 or less. Effective January 1, 2017, Section 9204 of the Public Contract Code prescribes a process for negotiation and mediation to resolve disputes on construction claims. The intent of this Section is to implement Sections 20104 et seq. and Section 9204 of the California Public Contract Code. This Section shall be construed to be consistent with said statutes.

3.10.2 Claims. For purposes of this Section, "Claim" means a separate demand by the Contractor, after a change order duly requested in accordance with the terms of this Contract has been denied by the City, for (A) a time extension, (B) payment of money or damages arising from Work done by or on behalf of the Contractor pursuant to the Contract, or (C) an amount the payment of which is disputed by the City. A "Claim" does not include any demand for payment for which the Contractor has failed to provide notice, request a change order, or otherwise failed to follow any procedures contained in the Contract Documents. Claims governed by this Section may not be filed unless and until the Contractor completes all procedures for giving notice of delay or change and for the requesting of a time extension or change order, including but not necessarily limited to the change order procedures contained herein, and Contractor's request for a change has been denied in whole or in part. Claims governed by this Section must be filed no later than fourteen (14) days after a request for change has been denied in whole or in part or after any other event giving rise to the Claim. The Claim shall be submitted in writing to the City and shall include on its first page the following in 16 point capital font: "THIS IS A CLAIM." Furthermore, the claim shall include the documents necessary to substantiate the claim. Nothing in this Section is intended to extend the time limit or supersede notice requirements otherwise provided by contract for the filing of claims, including all requirements pertaining to compensation or payment for extra Work, disputed Work, and/or changed conditions. Failure to follow such contractual requirements shall bar any claims or subsequent lawsuits for compensation or payment thereon.

3.10.3 Supporting Documentation. The Contractor shall submit all claims in the following format:

3.10.3.1 Summary of claim merit and price, reference Contract Document provisions pursuant to which the claim is made

3.10.3.2 List of documents relating to claim:

- (A) Specifications
- (B) Drawings
- (C) Clarifications (Requests for Information)
- (D) Schedules
- (E) Other

3.10.3.3 Chronology of events and correspondence

3.10.3.4 Analysis of claim merit

3.10.3.5 Analysis of claim cost

3.10.3.6 Time impact analysis in CPM format

3.10.3.7 If Contractor's claim is based in whole or in part on an allegation of errors or omissions in the Drawings or Specifications for the Project, Contractor shall provide a summary of the percentage of the claim subject to design errors or omissions and shall obtain a certificate of merit in support of the claim of design errors and omissions.

3.10.3.8 Cover letter and certification of validity of the claim, including any claims from subcontractors of any tier, in accordance with Government Code section 12650 *et seq.*

3.10.4 City's Response. Upon receipt of a claim pursuant to this Section, City shall conduct a reasonable review of the claim and, within a period not to exceed 45 days, shall provide the Contractor a written statement identifying what portion of the claim is disputed and what portion is undisputed. Any payment due on an undisputed portion of the claim will be processed and made within 60 days after the public entity issues its written statement.

3.10.4.1 If City needs approval from its governing body to provide the Contractor a written statement identifying the disputed portion and the undisputed portion of the claim, and the governing body does not meet within the 45 days or within the mutually agreed to extension of time following receipt of a claim sent by registered mail or certified mail, return receipt requested, City shall have up to three days following the next duly publicly noticed meeting of the governing body after the 45-day period, or extension, expires to provide the Contractor a written statement identifying the disputed portion and the undisputed portion.

3.10.4.2 Within 30 days of receipt of a claim, City may request in writing additional documentation supporting the claim or relating to defenses or claims City may have against the Contractor. If additional information is thereafter required, it shall be requested and provided pursuant to this subdivision, upon mutual agreement of City and the Contractor.

3.10.4.3 City's written response to the claim, as further documented, shall be submitted to the Contractor within 30 days (if the claim is less than \$50,000, within 15 days) after receipt of the further documentation, or within a period of time no greater than that taken by the Contractor in producing the additional information or requested documentation, whichever is greater.

3.10.5 Meet and Confer. If the Contractor disputes City's written response, or City fails to respond within the time prescribed, the Contractor may so notify City, in writing, either within 15 days of receipt of City's response or within 15 days of City's failure to respond within the time prescribed, respectively, and demand an informal conference to meet and confer for settlement of the issues in dispute. Upon receipt of a demand, City shall schedule a meet and confer conference within 30 days for settlement of the dispute.

3.10.6 Mediation. Within 10 business days following the conclusion of the meet and confer conference, if the claim or any portion of the claim remains in dispute, City shall provide the Contractor a written statement identifying the portion of the claim that remains in dispute and the portion that is undisputed. Any payment due on an undisputed portion of the claim shall be processed and made within 60 days after City issues its written statement. Any disputed portion of the claim, as identified by the Contractor in writing, shall be submitted to nonbinding mediation, with City and the Contractor sharing the associated costs equally. City and Contractor shall mutually agree to a mediator within 10 business days after the disputed portion of the claim has been identified in writing, unless the parties agree to select a mediator at a later time.

3.10.6.1 If the Parties cannot agree upon a mediator, each Party shall select a mediator and those mediators shall select a qualified neutral third party to mediate with regard to the disputed portion of the claim. Each Party shall bear the fees and costs charged by its respective mediator in connection with the selection of the neutral mediator.

3.10.6.2 For purposes of this section, mediation includes any nonbinding process, including, but not limited to, neutral evaluation or a dispute review board, in which an independent third party or board assists the Parties in dispute resolution through negotiation or by issuance of an evaluation. Any mediation utilized shall conform to the timeframes in this section.

3.10.6.3 Unless otherwise agreed to by City and the Contractor in writing, the mediation conducted pursuant to this section shall excuse any further obligation under Section 20104.4 to mediate after litigation has been commenced.

3.10.6.4 The mediation shall be held no earlier than the date the Contractor completes the Work or the date that the Contractor last performs Work, whichever is earlier. All unresolved claims shall be considered jointly in a single mediation, unless a new unrelated claim arises after mediation is completed.

3.10.7 Procedures After Mediation. If following the mediation, the claim or any portion remains in dispute, the Contractor must file a claim pursuant to Chapter 1 (commencing with Section 900) and Chapter 2 (commencing with Section 910) of Part 3 of Division 3.6 of Title 1 of the Government Code. For purposes of those provisions, the running of the period of time within which a claim must be filed shall be tolled from the time the Contractor submits his or her written claim pursuant to subdivision (a) until the time the claim is denied, including any period of time utilized by the meet and confer conference or mediation.

3.10.8 Civil Actions. The following procedures are established for all civil actions filed to resolve claims subject to this Section:

3.10.8.1 Within 60 days, but no earlier than 30 days, following the filing or responsive pleadings, the court shall submit the matter to non-binding mediation unless waived by mutual stipulation of both parties or unless mediation was held prior to commencement of the action in accordance with Public Contract Code section 9204 and the terms of these procedures.. The mediation process shall provide for the selection within 15 days by both parties of a disinterested third person as mediator, shall be commenced within 30 days of the submittal, and shall be concluded within 15 days from the commencement of the mediation unless a time requirement is extended upon a good cause showing to the court.

3.10.8.2 If the matter remains in dispute, the case shall be submitted to judicial arbitration pursuant to Chapter 2.5 (commencing with Section 1141.10) of Title 3 of Part 3 of the Code of Civil Procedure, notwithstanding Section 1114.11 of that code. The Civil Discovery Act of 1986 (Article 3 (commencing with Section 2016) of Chapter 3 of Title 3 of Part 4 of the Code of Civil Procedure) shall apply to any proceeding brought under this subdivision consistent with the rules pertaining to judicial arbitration.

3.10.8.3 In addition to Chapter 2.5 (commencing with Section 1141.10) of Title 3 of Part 3 of the Code of Civil Procedure, (A) arbitrators shall, when possible, be experienced in construction law, and (B) any party appealing an arbitration award who does not obtain a more favorable judgment shall, in addition to payment of costs and fees under that chapter, also pay the attorney's fees on appeal of the other party.

3.10.9 Government Code Claims. In addition to any and all contract requirements pertaining to notices of and requests for compensation or payment for extra work, disputed work, claims and/or changed conditions, Contractor must comply with the claim procedures set forth in Government Code sections 900 et seq. prior to filing any lawsuit against the City. Such

Government Code claims and any subsequent lawsuit based upon the Government Code claims shall be limited to those matters that remain unresolved after all procedures pertaining to extra work, disputed work, claims, and/or changed conditions have been followed by Contractor. If no such Government Code claim is submitted, or if any prerequisite contractual requirements are not otherwise satisfied as specified herein, Contractor shall be barred from bringing and maintaining a valid lawsuit against the City. A Government Code claim must be filed no earlier than the date the work is completed or the date the Contractor last performs work on the Project, whichever occurs first. A Government Code claim shall be inclusive of all unresolved claims unless a new unrelated claim arises after the Government Code claim is submitted.

3.10.10 Non-Waiver. City's failure to respond to a claim from the Contractor within the time periods described in this Section or to otherwise meet the time requirements of this Section shall result in the claim being deemed rejected in its entirety. City's failure to respond shall not waive City's rights to any subsequent procedures for the resolution of disputed claims.

3.11 Loss and Damage. Except as may otherwise be limited by law, Contractor shall be responsible for all loss and damage which may arise out of the nature of the Work agreed to herein, or from the action of the elements, or from any unforeseen difficulties which may arise or be encountered in the prosecution of the Work until the same is fully completed and accepted by City. In the event of damage proximately caused by an Act of God, as defined by Section 7105 of the Public Contract Code, the City may terminate this Contract pursuant to Section 3.17.3; provided, however, that the City needs to provide Contractor with only one (1) day advanced written notice.

### 3.12 Indemnification.

3.12.1 Scope of Indemnity. To the fullest extent permitted by law, Contractor shall defend (with counsel reasonably approved by City), indemnify and hold the City, its officials, employees, agents and authorized volunteers free and harmless from any and all claims, demands, causes of action, suits, actions, proceedings, costs, expenses, liability, judgments, awards, decrees, settlements, loss, damage or injury of any kind, in law or equity, to property or persons, including wrongful death, (collectively, "Claims") in any manner arising out of, pertaining to, or incident to any alleged acts, errors or omissions, or willful misconduct of Contractor, its officials, officers, employees, subcontractors, consultants or agents in connection with the performance of the Contractor's services, the Project or this Agreement, including without limitation the payment of all consequential damages, expert witness fees and attorneys' fees and other related costs and expenses. Notwithstanding the foregoing, to the extent required by Civil Code section 2782, Contractor's indemnity obligation shall not apply to liability for damages for death or bodily injury to persons, injury to property, or any other loss, damage or expense arising from the sole or active negligence or willful misconduct of the City or the City's agents, servants, or independent contractors who are directly responsible to the City, or for defects in design furnished by those persons.

3.12.2 Additional Indemnity Obligations. In addition, Contractor shall pay and satisfy any judgment, award or decree that may be rendered against City or its officials, employees, agents and authorized volunteers as part of any such claim, suit, action or other proceeding. Contractor shall also reimburse City for the cost of any settlement paid by City or its officials, employees, agents and authorized volunteers as part of any such claim, suit, action or other proceeding. Such reimbursement shall include payment for City's attorney's fees and costs, including expert witness fees. Contractor shall reimburse City and its officials, employees, agents and authorized volunteers, for any and all legal expenses and costs incurred by each of them in



connection therewith or in enforcing the indemnity herein provided. Contractor's obligation to indemnify shall not be restricted to insurance proceeds, if any, received by the City, its officials, employees, agents and authorized volunteers.

3.13 Insurance. Contractor agrees to procure and maintain, at Contractor's expense all insurance specified in Exhibit "H" attached hereto and by this reference incorporated herein. Contractor shall require all subcontractors to carry the same policies and limits of insurance that the Contractor is required to maintain, unless otherwise approved in writing by the City.

3.13.1

3.14 Bond Requirements.

3.14.1 Payment Bond. If required by law or otherwise specifically requested by City in Exhibit "C" attached hereto and incorporated herein by reference, Contractor shall execute and provide to City concurrently with this Contract a Payment Bond in an amount required by the City and in a form provided or approved by the City. If such bond is required, no payment will be made to Contractor until the bond has been received and approved by the City.

3.14.2 Performance Bond. If specifically requested by City in Exhibit "C" attached hereto and incorporated herein by reference, Contractor shall execute and provide to City concurrently with this Contract a Performance Bond in an amount required by the City and in a form provided or approved by the City. If such bond is required, no payment will be made to Contractor until the bond has been received and approved by the City.

3.14.3 Bond Provisions. Should, in City's sole opinion, any bond become insufficient or any surety be found to be unsatisfactory, Contractor shall renew or replace the effected bond within (ten) 10 days of receiving notice from City. In the event the surety or Contractor intends to reduce or cancel any required bond, at least thirty (30) days prior written notice shall be given to the City, and Contractor shall post acceptable replacement bonds at least ten (10) days prior to expiration of the original bonds. No further payments shall be deemed due or will be made under this Contract until any replacement bonds required by this Section are accepted by the City. To the extent, if any, that the Total Contract Price is increased in accordance with the Contract, Contractor shall, upon request of the City, cause the amount of the bond to be increased accordingly and shall promptly deliver satisfactory evidence of such increase to the City. If Contractor fails to furnish any required bond, the City may terminate the Contract for cause.

3.14.4 Surety Qualifications. Only bonds executed by an admitted surety insurer, as defined in California Code of Civil Procedure Section 995.120, shall be accepted. If a California-admitted surety insurer issuing bonds does not meet these requirements, the insurer will be considered qualified if it is in conformance with Section 995.660 of the California Code of Civil Procedure, and proof of such is provided to the City.

3.15 Warranty. Contractor warrants all Work under the Contract (which for purposes of this Section shall be deemed to include unauthorized work which has not been removed and any non-conforming materials incorporated into the Work) to be of good quality and free from any defective or faulty material and workmanship. Contractor agrees that for a period of one year (or the period of time specified elsewhere in the Contract or in any guarantee or warranty provided by any manufacturer or supplier of equipment or materials incorporated into the Work, whichever is later) after the date of final acceptance, Contractor shall within ten (10) days after being notified

in writing by the City of any defect in the Work or non-conformance of the Work to the Contract, commence and prosecute with due diligence all Work necessary to fulfill the terms of the warranty at its sole cost and expense. Contractor shall act sooner as requested by the City in response to an emergency. In addition, Contractor shall, at its sole cost and expense, repair and replace any portions of the Work (or work of other contractors) damaged by its defective Work or which becomes damaged in the course of repairing or replacing defective Work. For any Work so corrected, Contractor's obligation hereunder to correct defective Work shall be reinstated for an additional one year period, commencing with the date of acceptance of such corrected Work. Contractor shall perform such tests as the City may require to verify that any corrective actions, including, without limitation, redesign, repairs, and replacements comply with the requirements of the Contract. All costs associated with such corrective actions and testing, including the removal, replacement, and reinstatement of equipment and materials necessary to gain access, shall be the sole responsibility of Contractor. All warranties and guarantees of subcontractors, suppliers and manufacturers with respect to any portion of the Work, whether express or implied, are deemed to be obtained by Contractor for the benefit of the City, regardless of whether or not such warranties and guarantees have been transferred or assigned to the City by separate agreement and Contractor agrees to enforce such warranties and guarantees, if necessary, on behalf of the City. In the event that Contractor fails to perform its obligations under this Section, or under any other warranty or guaranty under this Contract, to the reasonable satisfaction of the City, the City shall have the right to correct and replace any defective or non-conforming Work and any work damaged by such work or the replacement or correction thereof at Contractor's sole expense. Contractor shall be obligated to fully reimburse the City for any expenses incurred hereunder upon demand.

### 3.16 Employee/Labor Certifications.

3.16.1 Contractor's Labor Certification. By its signature hereunder, Contractor certifies that he is aware of the provisions of Section 3700 of the California Labor Code which require every employer to be insured against liability for Worker's Compensation or to undertake self-insurance in accordance with the provisions of that Code, and agrees to comply with such provisions before commencing the performance of the Work. A certification form for this purpose, which is attached to this Contract as Exhibit "D" and incorporated herein by reference, shall be executed simultaneously with this Contract.

3.16.2 Equal Opportunity Employment. Contractor represents that it is an equal opportunity employer and that it shall not discriminate against any employee or applicant for employment because of race, religion, color, national origin, ancestry, sex, age or other interests protected by the State or Federal Constitutions. Such non-discrimination shall include, but not be limited to, all activities related to initial employment, upgrading, demotion, transfer, recruitment or recruitment advertising, layoff or termination.

3.16.3 Verification of Employment Eligibility. By executing this Contract, Contractor verifies that it fully complies with all requirements and restrictions of state and federal law respecting the employment of undocumented aliens, including, but not limited to, the Immigration Reform and Control Act of 1986, as may be amended from time to time, and shall require all subcontractors and sub-subcontractors to comply with the same.

### 3.17 General Provisions.

3.17.1 City's Representative. The City hereby designates the General Manager, or his or her designee, to act as its representative for the performance of this Contract ("City's

Representative"). City's Representative shall have the power to act on behalf of the City for all purposes under this Contract. Contractor shall not accept direction or orders from any person other than the City's Representative or his or her designee.

3.17.2 Contractor's Representative. Before starting the Work, Contractor shall submit in writing the name, qualifications and experience of its proposed representative who shall be subject to the review and approval of the City ("Contractor's Representative"). Following approval by the City, Contractor's Representative shall have full authority to represent and act on behalf of Contractor for all purposes under this Contract. Contractor's Representative shall supervise and direct the Work, using his best skill and attention, and shall be responsible for all construction means, methods, techniques, sequences and procedures and for the satisfactory coordination of all portions of the Work under this Contract. Contractor's Representative shall devote full time to the Project and either he or his designee, who shall be acceptable to the City, shall be present at the Work site at all times that any Work is in progress and at any time that any employee or subcontractor of Contractor is present at the Work site. Arrangements for responsible supervision, acceptable to the City, shall be made for emergency Work which may be required. Should Contractor desire to change its Contractor's Representative, Contractor shall provide the information specified above and obtain the City's written approval.

3.17.3 Termination. This Contract may be terminated by City at any time, either with or without cause, by giving Contractor three (3) days advance written notice. In the event of termination by City for any reason other than the fault of Contractor, City shall pay Contractor for all Work performed up to that time as provided herein. In the event of breach of the Contract by Contractor, City may terminate the Contract immediately without notice, may reduce payment to Contractor in the amount necessary to offset City's resulting damages, and may pursue any other available recourse against Contractor. Contractor may not terminate this Contract except for cause. In the event this Contract is terminated in whole or in part as provided, City may procure, upon such terms and in such manner as it may determine appropriate, services similar to those terminated. Further, if this Contract is terminated as provided, City may require Contractor to provide all finished or unfinished documents, data, diagrams, drawings, materials or other matter prepared or built by Contractor in connection with its performance of this Contract.

3.17.4 Contract Interpretation. Should any question arise regarding the meaning or import of any of the provisions of this Contract or written or oral instructions from City, the matter shall be referred to City's Representative, whose decision shall be binding upon Contractor.

3.17.5 Anti-Trust Claims. This provision shall be operative if this Contract is applicable to California Public Contract Code Section 7103.5. In entering into this Contract to supply goods, services or materials, Contractor hereby offers and agrees to assign to the City all rights, title, and interest in and to all causes of action it may have under Section 4 of the Clayton Act (15 U.S.C. Section 15) or under the Cartwright Act (Chapter 2, commencing with Section 16700, of Part 2 of Division 7 of the Business and Professions Code) arising from purchases of goods, services, or materials pursuant to the Contract. This assignment shall be made and become effective at the time the City tender final payment to Contractor, without further acknowledgment by the Parties.

3.17.6 Notices. All notices hereunder and communications regarding interpretation of the terms of the Contract or changes thereto shall be provided by the mailing thereof by registered or certified mail, return receipt requested, postage prepaid and addressed as follows:

**CONTRACTOR:**

DBA Ferreira Coastal Construction Co.  
10370 Commerce Center Drive Suite B-200  
Rancho Cucamonga, CA 91730  
Attn: Javier Flores

**CITY:**

City of San Clemente  
910 Calle Negocio  
San Clemente, CA 92673  
Attn: Amir K. Ilkhanipour, Principal Civil Engineer

Any notice so given shall be considered received by the other Party three (3) days after deposit in the U.S. Mail as stated above and addressed to the Party at the above address. Actual notice shall be deemed adequate notice on the date actual notice occurred, regardless of the method of service.

3.17.7 Time of Essence. Time is of the essence in the performance of this Contract.

3.17.8 Assignment Forbidden. Contractor shall not, either voluntarily or by action of law, assign or transfer this Contract or any obligation, right, title or interest assumed by Contractor herein without the prior written consent of City. If Contractor attempts an assignment or transfer of this Contract or any obligation, right, title or interest herein, City may, at its option, terminate and revoke the Contract and shall thereupon be relieved from any and all obligations to Contractor or its assignee or transferee.

3.17.9 No Third Party Beneficiaries. There are no intended third party beneficiaries of any right or obligation assumed by the Parties.

3.17.10 Laws, Venue, and Attorneys' Fees. This Agreement shall be interpreted in accordance with the laws of the State of California. If any action is brought to interpret or enforce any term of this Agreement, the action shall be brought in a state or federal court situated in the County of Orange, State of California.

3.17.11 Counterparts. This Contract may be executed in counterparts, each of which shall constitute an original.

3.17.12 Successors. The Parties do for themselves, their heirs, executors, administrators, successors, and assigns agree to the full performance of all of the provisions contained in this Contract.

3.17.13 [Reserved]

3.17.14 Solicitation. Contractor maintains and warrants that it has not employed nor retained any company or person, other than a bona fide employee working solely for Contractor, to solicit or secure this Contract. Further, Contractor warrants that it has not paid nor has it agreed to pay any company or person, other than a bona fide employee working solely for Contractor, any fee, commission, percentage, brokerage fee, gift or other consideration contingent upon or resulting from the award or making of this Contract. For breach or violation of this warranty, City shall have the right to terminate this Contract without liability.

3.17.15 Conflict of Interest. Contractor maintains and warrants that it has not employed nor retained any company or person, other than a bona fide employee working solely for Contractor, to solicit or secure this Agreement. Further, Contractor warrants that it has not paid nor has it agreed to pay any company or person, other than a bona fide employee working solely for Contractor, any fee, commission, percentage, brokerage fee, gift or other consideration contingent upon or resulting from the award or making of this Agreement. For breach or violation of this warranty, City shall have the right to rescind this Agreement without liability. For the term of this Contract, no official, officer or employee of City, during the term of his or her service with City, shall have any direct interest in this Contract, or obtain any present or anticipated material benefit arising therefrom. In addition, Contractor agrees to file, or to cause its employees or subcontractors to file, a Statement of Economic Interest with the City's Filing Officer as required under state law in the performance of the Work.

3.17.16 Certification of License.

3.17.16.1 Contractor certifies that as of the date of execution of this Contract, Contractor has a current contractor's license of the classification indicated below under Contractor's signature.

3.17.16.2 Contractors are required by law to be licensed and regulated by the Contractors' State License Board which has jurisdiction to investigate complaints against contractors if a complaint regarding a patent act or omission is filed within four (4) years of the date of the alleged violation. A complaint regarding a latent act or omission pertaining to structural defects must be filed within ten (10) years of the date of the alleged violation. Any questions concerning a contractor may be referred to the Registrar, Contractors' State License Board, P.O. Box 26000, Sacramento, California 95826.

3.17.17 Authority to Enter Contract. Each Party warrants that the individuals who have signed this Contract have the legal power, right and authority to make this Contract and bind each respective Party.

3.17.18 Entire Contract; Modification. This Contract contains the entire agreement of the Parties with respect to the subject matter hereof, and supersedes all prior negotiations, understandings or agreements. This Contract may only be modified by a writing signed by both Parties.

3.17.19 Non-Waiver. None of the provisions of this Agreement shall be considered waived by either party, unless such waiver is specifically specified in writing.

3.17.20 City's Right to Employ Other Contractors. City reserves right to employ other contractors in connection with this Project or other projects.

3.17.21 Federal Provisions (NOT APPLICABLE). When funding for the Services is provided, in whole or in part, by an agency of the federal government, Contractor shall also fully and adequately comply with the provisions included in Exhibit "G" (Federal Requirements) attached hereto and incorporated herein by reference ("Federal Requirements"). With respect to any conflict between such Federal Requirements and the terms of this Agreement and/or the provisions of state law, the more stringent requirement shall control.

**[SIGNATURES ON NEXT PAGE]**



IN WITNESS WHEREOF, the parties hereto have caused this Agreement to be duly executed on the respective dates set forth opposite of their signatures.

CITY OF SAN CLEMENTE

By: Jan Joyce

Its: Interim City manager

Dated: 9-20, 2022

ATTEST:

Jan Camy *Legislative Administrator*  
CITY CLERK of the City of  
San Clemente, California

APPROVED AS TO FORM:  
BEST BEST & KRIEGER

[Signature]  
City Attorney

APPROVED AS TO AVAILABILITY  
OF FUNDING:

[Signature]  
Finance Authorization

Ferreira Construction Co. Inc. dba  
Ferreira Coastal Construction Co.  
("CONTRACTOR")

By: [Signature]

Its: Brandon Pensick - Senior Vice President

Dated: September 15, 2022

IN WITNESS WHEREOF, the parties hereto have caused this Agreement to be duly executed on the respective dates set forth opposite of their signatures.

**CITY OF SAN CLEMENTE**

By: \_\_\_\_\_

Its: \_\_\_\_\_

Dated: \_\_\_\_\_, 20\_\_

**ATTEST:**

\_\_\_\_\_  
CITY CLERK of the City of  
San Clemente, California

**APPROVED AS TO FORM:  
BEST BEST & KRIEGER**

\_\_\_\_\_  
City Attorney

**APPROVED AS TO AVAILABILITY  
OF FUNDING:**

\_\_\_\_\_  
Finance Authorization

Ferreira Construction Co. Inc. dba  
Ferreira Coastal Construction Co.  
("CONTRACTOR")

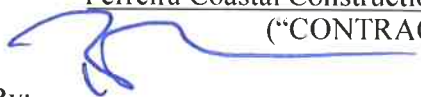
  
By: \_\_\_\_\_

Its: Brandon Pensick - Senior Vice President

Dated: September 15, 20 22

**EXHIBIT "A"**  
**SERVICES / SCHEDULE**

**(SEE ATTACHED)**

## Ohana, Jacob

---

**From:** Javier Flores <JFlores@ferreiraconstruction.com>  
**Sent:** Tuesday, September 6, 2022 2:37 PM  
**To:** Ohana, Jacob; Ilkhanipour, Amir  
**Cc:** Dave Baker  
**Subject:** RE: 216 La Cuesta Manhole Construction  
**Attachments:** City of San Clemente - 216 La Cuesta Sanitary Sewer MH Install - Proposal Rev.pdf

Amir,  
Per our conversation, please see attached.

Regards,

**Javier Flores**

*Project Manager*

O 909.606.5900 M 909.270.7342

10370 Commerce Center Dr., Suite B-200

Rancho Cucamonga, CA 91730

FerreiraConstruction.com 

**FERREIRA**

Building the Future with Pride

**From:** Ohana, Jacob <ohana@san-clemente.org>  
**Sent:** Wednesday, August 31, 2022 2:14 PM  
**To:** Ilkhanipour, Amir <IlkhanipourA@san-clemente.org>; mark@oconnelleng.com; alan@gciconstruction.com; Javier Flores <JFlores@ferreiraconstruction.com>; Dave Baker <DBaker@ferreiraconstruction.com>; tdg@gciconstruction.com  
**Subject:** FW: 216 La Cuesta Manhole Construction

Hello All,

Pursuant to our field meeting, attached to this email is a blank version of the construction contract that will be executed and the manhole standard to be used in this project. If you are interested in this project, please provide a proposal to include the following items:

- 1.) Mobilization including some tree branch removal
- 2.) Construct a sewer manhole per SPPWC 200-4 standard (attached)
- 3.) Shoring
- 4.) Backfill around manhole with slurry fill or CMB with top 2 feet with top soil
- 5.) Waste Management
- 6.) Slurry fill 8" sewer pipe and manhole (~10 cubic yards)

Other relevant information:

High strength concrete hand mixing is acceptable

- Payment and performance bonds required
- Insurance per the attached sample agreement is required
- This is a prevailing wage project
- This is a Public Works project and prevailing wages will be applied and certified payrolls will need to be submitted to the City of San Clemente and uploaded to Department of Industrial Relations (DIR).

Please submit your proposals via email by Tuesday September 6<sup>th</sup>, 2022, before 4:00 pm. Please let me know if you need additional time.

Thanks,

Jake

**DISCLAIMER:** This e-mail may contain information that is confidential, privileged or otherwise protected from disclosure. If you are not an intended recipient of this e-mail, do not duplicate or redistribute it by any means. Please delete it and any attachments and notify the sender that you have received it in error. Unintended recipients are prohibited from taking action on the basis of information in this e-mail. E-mail messages may contain computer viruses or other defects, may not be accurately replicated on other systems, or may be intercepted, deleted or interfered with without the knowledge of the sender or the intended recipient. By using email to communicate, you are accepting the risks associated with e-mail messages. Our organization reserves the right, to the extent and under circumstances permitted by applicable law, to retain, monitor and intercept e-mail messages to and from its systems.

**DISCLAIMER:** This e-mail may contain information that is confidential, privileged or otherwise protected from disclosure. If you are not an intended recipient of this e-mail, do not duplicate or redistribute it by any means. Please delete it and any attachments and notify the sender that you have received it in error. Unintended recipients are prohibited from taking action on the basis of information in this e-mail. E-mail messages may contain computer viruses or other defects, may not be accurately replicated on other systems, or may be intercepted, deleted or interfered with without the knowledge of the sender or the intended recipient. By using email to communicate, you are accepting the risks associated with e-mail messages. Our organization reserves the right, to the extent and under circumstances permitted by applicable law, to retain, monitor and intercept e-mail messages to and from its systems.

#### **Disclaimer**

The information contained in this communication from the sender is confidential. It is intended solely for use by the recipient and others authorized to receive it. If you are not the recipient, you are hereby notified that any disclosure, copying, distribution or taking action in relation of the contents of this information is strictly prohibited and may be unlawful.

This email has been scanned for viruses and malware, and may have been automatically archived by **Mimecast Ltd**, an innovator in Software as a Service (SaaS) for business. Providing a **safer and more useful** place for your human generated data. Specializing in; Security, archiving and compliance. To find out more [Click Here](#).

# FERREIRA

DRA FERREIRA COASTAL CONSTRUCTION CO.

<b>JOB NAME:</b> FCC#5301 -CA Small Jobs - Utilities	<b>DATE:</b> 8/31/2022
--	------------------------

PCO#  
Cost Code 23-23000  
Title: San Clemente 216 Avenida La Cuesta SSMH

Date	Description	Amount
Day1	Mobilize, Remove tree branches, Trench and Shore for Proposed Sanitary Sewer Manhole	\$ 6,210.22
Day2	Continue Trenching and Shoring for Sanitary Sewer Manhole	\$ 6,210.22
Day3	Assist Underground Manholes with pour of manhole base (Mix on-site with pre-mix concrete bags)	\$ 3,971.33
Day4	Stack manhole shafting and backfill with CMB, top 2 feet with topsoil	\$ 17,573.91
Day5	Pour concrete collar, Slurry fill 8" sewer pipe and existing manhole, clean and demobilize	\$ 8,805.62
	Bond (1%)	\$ 427.71
	<b>Total Amount</b>	<b>\$ 43,199.02</b>

**Notes:**

Please carefully review and note the following Inclusions, exclusions, conditions, qualifications and terms of this proposal.

Any item not clearly indicated in this Scope of Work is excluded from this proposal.

This proposal is good for 30 calendar days from the date issued. Ferreira Construction Co. Inc reserves the right to change, withdraw, or alter its proposal after this time

Spoils to be taken to City of San Clemente's yard

**Exclusions:**

Construction water is excluded. Supplied by others.

Permits and Fees: All development fees, water/sewer use fees, plan check fees are excluded.

Material Testing

Landscape and irrigation restorations



# FERREIRA

DBA FERREIRA COASTAL CONSTRUCTION CO.

JOB NAME: FCC#5301 -CA Small Jobs - Utilities DATE:

Filename: T&M Report Dated :

Total Labor		4,245.58
Labor Surcharge	0%	0.00
Labor Markup	0%	0.00
Total Materials		0.00
Sales Tax	7.75%	0.00
Material Markup	15%	0.00
Total Equipment		1,708.40
Equipment Markup	15%	256.26
Total Subcontractors		0.00
Sub Markup	5%	0.00
<b>Grand Total</b>		<b>6,210.22</b>

JOB NAME: FCC#5301 -CA Small Jobs - Utilities DATE: 1/0/1900

**Labor**

Name	Labor Type	QTY	U/M	Rate	U/M	EXT	OT HR	OT Rate	U/M	EXT
300 Labor Foreman VI		8	hrs	\$121.95	hrs	\$ 975.60	1	\$182.92	hrs	\$ 182.92
300 Laborer IV		8	hrs	\$117.64	hrs	\$ 941.12		\$176.47	hrs	\$ -
986/420 Driver		8	hrs	\$116.90	hrs	\$ 935.20		\$175.34	hrs	\$ -
Local 12 VIII		8	hrs	\$151.34	hrs	\$ 1,210.72		\$227.01	hrs	\$ -
			hrs		hrs				hrs	
<b>TOTAL</b>						<b>\$ 4,062.64</b>				<b>\$ 182.92</b>

**Owned Equipment**

Equip #	Model	QTY	U/M	PRICE	U/M	EXT	SB HR	OT Factor	U/M	EXT
T-104	Ford F-550/ Contractor Body (19.5K LBS)	8	hrs	\$37.19	hrs	\$ 297.52		0.88	hrs	\$ -
AC-28	Vanair 185 Under Deck Compressor	8	hrs	\$20.80	hrs	\$ 166.40		0.87	hrs	\$ -
DT-03	GMC 5500/ Mason Dump (GVWR 19.5K LBS)	8	hrs	\$39.41	hrs	\$ 315.28		0.88	hrs	\$ -
T-96	Ford F-250/Reg Cab Pickup (.GVWR 10K LBS)	8	hrs	\$28.65	hrs	\$ 229.20		0.88	hrs	\$ -
			hrs		hrs				hrs	
<b>TOTAL</b>						<b>\$ 1,008.40</b>				<b>\$ -</b>

**Rental Equipment**

Equipment	Model No	QTY	U/M	PRICE	U/M	EXT
Shoring		1	Day	\$300.00		\$ 300.00
Mini Excavator		1	Day	\$400.00		\$ 400.00
			hrs			\$ -
			hrs			\$ -
<b>TOTAL</b>						<b>\$ 700.00</b>

**Subcontractors / Contractor**

Name	QTY	U/M	PRICE	U/M	EXT
		LS	0.00	LS	\$ -
		LS	0.00	LS	\$ -
<b>TOTAL</b>					<b>\$ -</b>

**Materials**

Name	QTY	U/M	PRICE	U/M	EXT	RECEIPT #	CUSTOMER
		CY		LS	\$ -		
		LS		LS	\$ -		
		LS		LS	\$ -		
		LS		LS	\$ -		
<b>TOTAL</b>					<b>\$ -</b>		



DBA FERREIRA COASTAL CONSTRUCTION CO.

JOB NAME: FCC#5301 -CA Small Jobs - Utilities DATE: 8/16/2022  
 Filename: T&M Report Dated :

Total Labor		4,245.56
Labor Surcharge	0%	0.00
Labor Markup	0%	0.00
Total Materials		0.00
Sales Tax	7.75%	0.00
Material Markup	15%	0.00
Total Equipment		1,708.40
Equipment Markup	15%	256.26
Total Subcontractors		0.00
Sub Markup	5%	0.00
Grand Total		6,210.22

JOB NAME: FCC#5301 -CA Small Jobs - Utilities DATE: 8/16/2022

Labor										
Name	QTY	UM	Rate	UM	EXT	OT HR	OT Rate	UM	EXT	
300 Labor Foreman VI	8	hrs	\$121.95	hrs	\$ 975.60	1		\$182.92	hrs	\$ 182.92
300 Laborer IV	8	hrs	\$117.64	hrs	\$ 941.12			\$176.47	hrs	\$ -
986/420 Driver	8	hrs	\$116.90	hrs	\$ 935.20			\$175.34	hrs	\$ -
Local 12 Vill	8	hrs	\$151.34	hrs	\$ 1,210.72			\$227.01	hrs	\$ -
				hrs					hrs	
TOTAL					\$ 4,062.64					\$ 182.92

Owned Equipment											
Equip #	Model	QTY	UM	PRICE	UM	EXT	SR HR	OT Factor	UM	EXT	
T-104	Ford F-550/ Contractor Body (19.5K LBS)	8	hrs	\$37.19	hrs	\$ 297.52			0.88	hrs	\$ -
AC-28	Vanair 185 Under Deck Compressor	8	hrs	\$20.80	hrs	\$ 166.40			0.67	hrs	\$ -
	GMC 5500/ Mason Dump (GVWR 19.5K LBS)	8	hrs	\$39.41	hrs	\$ 315.28			0.88	hrs	\$ -
OT-03	Ford F-250/Reg Cab Pickup ( GVWR 10K LBS)	8	hrs	\$28.65	hrs	\$ 229.20			0.88	hrs	\$ -
T-96					hrs					hrs	
TOTAL					\$ 1,008.40					\$ -	

Rental Equipment										
Equipment	Model No	QTY	UM	PRICE	UM	EXT	SR	OT	UM	EXT
Shoring		1	Day	\$300.00		\$ 300.00				
Mini Excavator		1	Day	\$400.00		\$ 400.00				
			hrs			\$ -				
			hrs			\$ -				
TOTAL					\$ 700.00					

Subcontractors / Contractor										
Name	QTY	UM	PRICE	UM	EXT	SR	OT	UM	EXT	
		LS	0.00	LS	\$ -					
		LS	0.00	LS	\$ -					
TOTAL					\$ -					

Materials										
Name	QTY	UM	PRICE	UM	EXT	RECEIPT #	CUSTOMER			
		CY		LS	\$ -					
		LS		LS	\$ -					
		LS		LS	\$ -					
		LS		LS	\$ -					
TOTAL					\$ -					



# FERREIRA

DR. FERREIRA COASTAL CONSTRUCTION CO.

JOB NAME: FCC#5301 -CA Small Jobs - Utilities

DATE: 8/16/2022

Filename: T&M Report Dated :

Total Labor		4,245.56
Labor Surcharge	0%	0.00
Labor Markup	0%	0.00
Total Materials		1,050.00
Sales Tax	7.75%	81.38
Material Markup	15%	169.71
Total Equipment		3,793.28
Equipment Markup	15%	568.99
Total Subcontractors		7,300.00
Sub Markup	5%	365.00
Grand Total		17,573.91

JOB NAME: FCC#5301 -CA Small Jobs - Utilities

DATE: 8/16/2022

### Labor

Name	Labor Type	QTY	UNIT	PRICE	UNIT	EXT	OT HR	OT Rate	UNIT	EXT
300 Labor Foreman VI		8	hrs	\$121.95	hrs	\$ 975.60	1		\$182.92	hrs \$ 182.92
300 Laborer IV		8	hrs	\$117.64	hrs	\$ 941.12			\$176.47	hrs \$ -
Local 12 VIII		8	hrs	\$151.34	hrs	\$ 1,210.72			\$227.01	hrs \$ -
986/420 Driver		8	hrs	\$116.90	hrs	\$ 935.20			\$175.34	hrs \$ -
			hrs		hrs					hrs \$ -
TOTAL						\$ 4,062.64				\$ 182.92

### Owned Equipment

Equip. #	Model	QTY	UNIT	PRICE	UNIT	EXT	SP HR	OT Factor	UNIT	EXT
T-104	Ford F-650/ Contractor Body (19.6K LBS)	40	hrs	\$37.19	hrs	\$ 1,487.60		0.88	hrs	\$ -
AC-28	Vanair 185 Under Deck Compressor	40	hrs	\$20.80	hrs	\$ 832.00		0.87	hrs	\$ -
T-96	Ford F-250/Reg Cab Pickup ( GVWR 10K LBS)	16	hrs	\$28.65	hrs	\$ 458.40		0.88	hrs	\$ -
DT-03	GMC 5500/ Mason Dump (GVWR 19.5K LBS)	8	hrs	\$39.41	hrs	\$ 315.28		0.88	hrs	\$ -
			hrs		hrs				hrs	\$ -
TOTAL						\$ 3,093.28				\$ -

### Rental Equipment

Equipment	Model No.	QTY	UNIT	PRICE	UNIT	EXT	SP HR	OT Factor	UNIT	EXT
Shoring		1	LS	\$300.00		\$ 300.00				
Mini Excavator		1	Day	\$400.00		\$ 400.00				
			hrs			\$ -				
			hrs			\$ -				
TOTAL						\$ 700.00				

### Subcontractors / Contractor

Name	QTY	UNIT	PRICE	UNIT	EXT	RECEIPT #	CUSTOMER
Underground Manholes	1	LS	7,300.00	LS	\$ 7,300.00		
		LS		LS	\$ -		
TOTAL						\$ 7,300.00	

### Materials

Name	QTY	UNIT	PRICE	UNIT	EXT	RECEIPT #	CUSTOMER
Crushed Misc. Base	35	Ton	\$30.00	LS	\$ 1,050.00		
		LS		LS	\$ -		
		LS		LS	\$ -		
		LS		LS	\$ -		
TOTAL						\$ 1,050.00	





CSA FERREIRA COASTAL CONSTRUCTION CO.

JOB NAME: FCC#5301 -CA Small Jobs - Utilities

DATE: 8/16/2022

Filename: T&M Report Dated :

Total Labor		4,251.48
Labor Surcharge	0%	0.00
Labor Markup	0%	0.00
Total Materials		1,535.00
Sales Tax	7.75%	118.98
Material Markup	15%	248.09
Total Equipment		1,393.12
Equipment Markup	15%	208.97
Total Subcontractors		1,000.00
Sub Markup	5%	50.00
Grand Total		8,805.62

JOB NAME: FCC#5301 -CA Small Jobs - Utilities

DATE: 8/16/2022

**Labor**

Name	Labor Type	QTY	U/M	Rate	U/M	EXT	OT HR	OT Rate	U/M	EXT
300 Labor Foreman VI		8	hrs	\$121.95	hrs	\$ 975.60	1	\$182.92	hrs	\$ 182.92
Local 12 VIII		8	hrs	\$151.34	hrs	\$ 1,210.72		\$227.01	hrs	\$ -
300 Laborer IV		8	hrs	\$117.64	hrs	\$ 941.12		\$176.47	hrs	\$ -
300 Laborer IV		8	hrs	\$117.64	hrs	\$ 941.12		\$176.47	hrs	\$ -
			hrs		hrs				hrs	
TOTAL						\$ 4,068.56				\$ 182.92

**Owned Equipment**

Equip #	Model	QTY	U/M	PRICE	U/M	EXT	SR HR	OT Factor	U/M	EXT
T-104	Ford F-550/ Contractor Body (18.5K LBS)	8	hrs	\$37.19	hrs	\$ 297.52		0.88	hrs	\$ -
AC-28	Vanair 185 Under Deck Compressor	8	hrs	\$20.80	hrs	\$ 166.40		0.87	hrs	\$ -
T-96	Ford F-250/Reg Cab Pickup ( GVWR 10K LBS)	8	hrs	\$28.65	hrs	\$ 229.20		0.88	hrs	\$ -
			hrs		hrs				hrs	
			hrs		hrs				hrs	
TOTAL						\$ 693.12				\$ -

**Rental Equipment**

Equipment	Model No.	QTY	U/M	PRICE	U/M	EXT
Shoring		1	LS	\$300.00	LS	\$ 300.00
Mini Excavator		1	Day	\$400.00	Day	\$ 400.00
			hrs		hrs	\$ -
			hrs		hrs	\$ -
TOTAL						\$ 700.00

**Subcontractors / Contractor**

Name	QTY	U/M	PRICE	U/M	EXT	
Pump	1	LS	1,000.00	LS	\$ 1,000.00	
		LS		LS	\$ -	
TOTAL						\$ 1,000.00

**Materials**

Name	QTY	U/M	PRICE	U/M	EXT	RECEIPT #	CUSTOMER
Sono Tube	3	LF	\$120.00	LS	\$ 360.00		
Bagged Concrete (35 Bags)	1	LS	\$175.00	LS	\$ 175.00		
1 Sack Slurry	10	CY	\$100.00	LS	\$ 1,000.00		
		LS		LS	\$ -		
TOTAL						\$ 1,535.00	

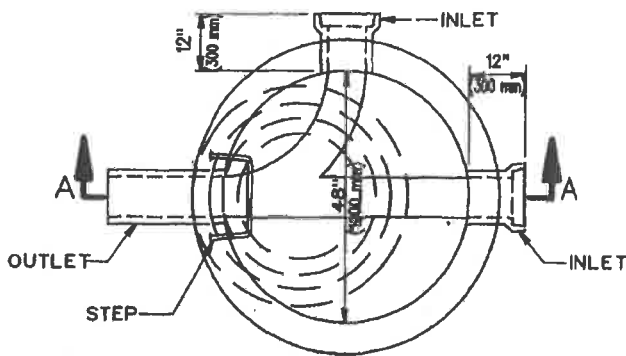

**PLAN**  
SHOWING BASE

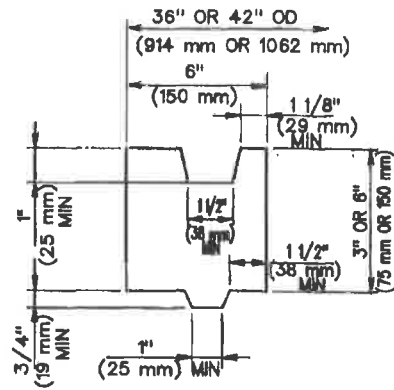

**ADJUSTING RING DETAIL**

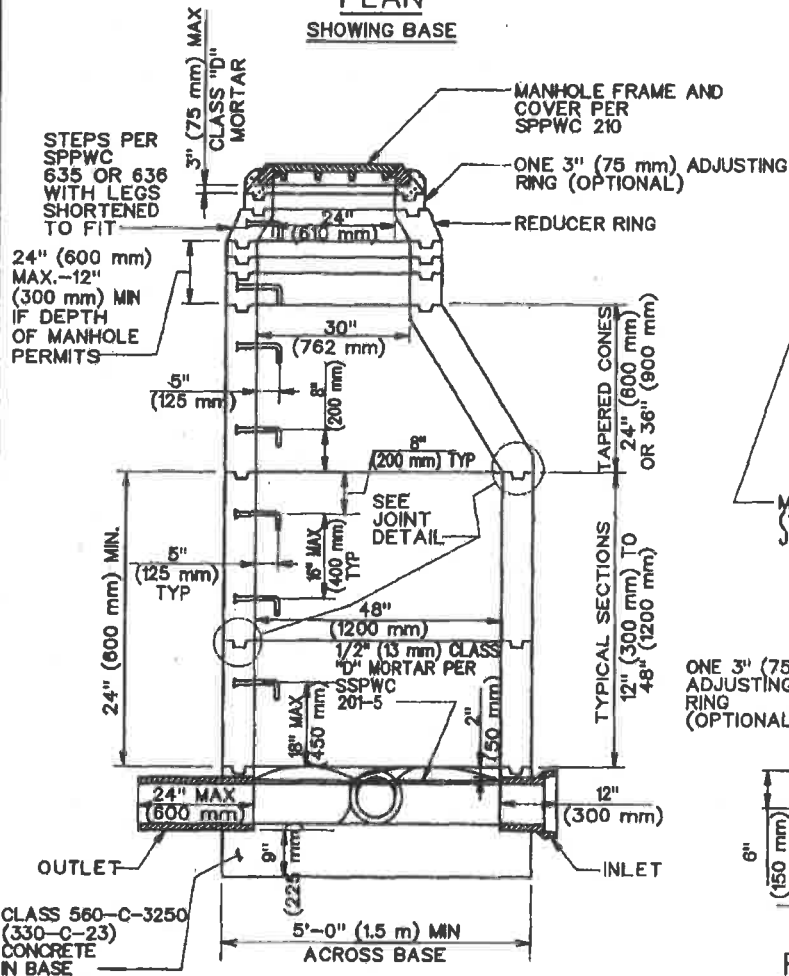

**SECTION A-A**

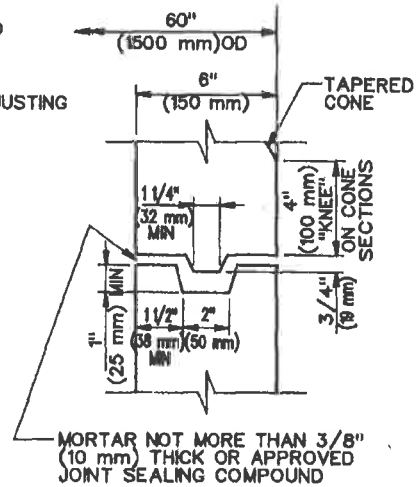

**JOINT DETAIL**  
NON-REINFORCED

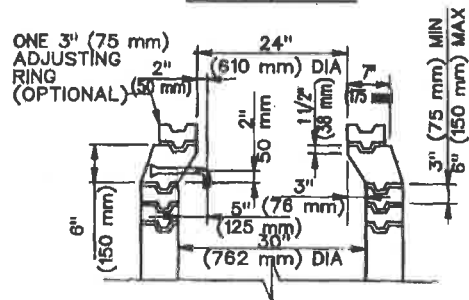

**REDUCER RING AND ADJUSTING RINGS**

STANDARD PLANS FOR PUBLIC WORKS CONSTRUCTION

PROLARGATED BY THE  
PUBLIC WORKS STANDARDS INC.  
GREENBOOK COMMITTEE  
1954  
REV. 1963, 1990, 2008, 2021

**PRECAST CONCRETE  
SEWER MANHOLE**

USE WITH STANDARD SPECIFICATIONS FOR PUBLIC WORKS CONSTRUCTION

STANDARD PLAN

**200-4**

SHEET 1 OF 2



**NOTES:**

1. EXCEPT AS NOTED HEREON, THE PRECAST UNITS SHALL BE MANUFACTURED AND TESTED IN ACCORDANCE WITH ASTM C478 (C478M). AS AN ALTERNATE CURING METHOD, THE UNITS MAY BE CURED USING SATURATED STEAM FOR A MINIMUM OF 12 HOURS FOLLOWED BY 6 DAYS OF WATER CURING OR MEMBRANE CURING. IF THE UNITS ARE CURED BY THE ALTERNATE METHOD, THEY SHALL NOT BE SHIPPED PRIOR TO 8 DAYS AFTER CASTING NOR UNTIL THE CONCRETE HAS ATTAINED A STRENGTH OF 3500 PSI (25 MPa)
2. MANHOLE STEPS SHALL CONFORM TO SPPWC 635 TYPE 1 OR 3 OR SPPWC 636. THE MANHOLE STEPS SHALL BE UNIFORMLY SPACED AT A MAXIMUM OF 16" (400 mm). THE LOWEST STEP SHALL BE PLACED NOT LESS THAN 8" (200 mm) NOR MORE THAN 18" (450 mm) ABOVE THE SHELF. THE STEPS SHALL PROJECT 5" (125 mm) INSIDE THE MANHOLE.
3. RISER SECTIONS MAY BE REINFORCED OR UNREINFORCED. REINFORCED SECTIONS SHALL BE REINFORCED IN ACCORDANCE WITH ASTM C478 (C478M) AND SHALL HAVE A MINIMUM WALL THICKNESS OF 5" (125 mm). UNREINFORCED RISER SECTIONS SHALL HAVE A MINIMUM WALL THICKNESS OF 6" (150 mm).
4. THE 24" x 48" (600 mm x 1200 mm) ECCENTRIC CONES MAY BE REINFORCED OR UNREINFORCED. IF REINFORCED, THE WALL THICKNESS SHALL BE NOT LESS THAN 5" (125 mm). IF UNREINFORCED, THE WALL THICKNESS SHALL NOT BE LESS THAN 6" (150 mm).
5. JOINTS SHALL BE TONGUE AND GROOVE. JOINTS FOR REINFORCED STRUCTURES SHALL CONFORM WITH ASTM C478 (C478M) SECTION 14.
6. PRECAST UNITS SHALL BE ASSEMBLED USING CLASS "B" MORTAR.
7. IF 30" (762 mm) DIAMETER MANHOLE FRAME AND COVER IS REQUIRED, IT SHALL BE INSTALLED WHERE THE REDUCER RING IS SHOWN IN THE SECTION.
8. FOR REINFORCED PRECAST STRUCTURES, ALL REINFORCEMENT SHALL HAVE A MINIMUM OF 2" (50 mm) OF COVER OVER THE STEEL ON THE INSIDE FACE.
9. THE TOP OPENING OF THE MANHOLE AND THE STEPS SHALL BE PLACED DIRECTLY OVER THE OUTLET OF THE STRUCTURE EXCEPT AS OTHERWISE NOTED ON PLANS.
10. CONCRETE BASE AND STUB WALLS SHALL BE POURED IN ONE OPERATION TO A POINT 2" (50 mm) ABOVE THE INLET AND OUTLET PIPES. ALL PIPES SHALL BE RIGIDLY SUPPORTED BY TEMPORARY PIERS OR OTHER METHODS DURING THE OPERATION. CONCRETE SHALL SET FOR 24 HOURS BEFORE PLACING PRECAST UNITS.

STANDARD PLANS FOR PUBLIC WORKS CONSTRUCTION

**PRECAST CONCRETE SEWER MANHOLE**

STANDARD PLAN

**200-4**

SHEET 2 OF 2

**EXHIBIT "B"**  
**PLANS AND SPECIFICATIONS**  
**(SEE ATTACHED EXHIBIT A)**

**EXHIBIT "C"**

**SPECIAL CONDITIONS**

**ARTICLE 1. BONDS**

Within ten (10) calendar days from the date the Contractor is notified of award of the Contract, the Contractor shall deliver to the City four identical counterparts of the Performance Bond and Payment Bond on the forms supplied by the City and included as Exhibit "F" to the Contract. Failure to do so may, in the sole discretion of City, result in the forfeiture of Contractor's bid security. The surety supplying the bond must be an admitted surety insurer, as defined in Code of Civil Procedure Section 995.120, authorized to do business as such in the State of California and satisfactory to the City. The Performance Bond and the Payment Bond shall be for one hundred percent (100%) of the Total Contract Price.

EXHIBIT "D"

WORKERS COMPENSATION INSURANCE CERTIFICATION

WORKERS' COMPENSATION DECLARATION

I hereby affirm under penalty of perjury one of the following declarations:

**(ONE OF THE BOXES BELOW MUST BE CHECKED)**

I have and will maintain a certificate of consent from the California Labor Commission to self-insure for workers' compensation, as provided for by Section 3700 of the Labor Code, for the performance of the work to be performed under this contract.

I have and will maintain workers' compensation insurance, as required by Section 3700 of the Labor Code, for the performance of the work to be performed under this contract. My workers' compensation insurance carrier and policy number are:

Carrier Liberty Mutual Fire Insurance Co.

Policy Number WA263D510814032

I certify that, in the performance of the work under this Agreement, I shall not employ any person in any manner so as to become subject to the workers' compensation laws of California, and I hereby agree to indemnify, defend, and hold harmless the City of San Clemente and all of its officials, employees, and agents from and against any and all claims, liabilities, and losses relating to personal injury or death, economic losses, and property damage arising out of my failure to provide such worker's compensation insurance. I further agree that, if I should become subject to the workers' compensation provisions of Section 3700 of the Labor Code, I shall forthwith comply with those provisions.

**WARNING: FAILURE TO SECURE WORKERS' COMPENSATION COVERAGE IS UNLAWFUL, AND SHALL SUBJECT AN EMPLOYER TO CRIMINAL PENALTIES AND CIVIL FINES UP TO ONE HUNDRED THOUSAND DOLLARS (\$100,000), IN ADDITION TO THE COST OF COMPENSATION, DAMAGES AS PROVIDED FOR IN SECTION 3706 OF THE LABOR CODE, INTEREST, AND ATTORNEY'S FEES.**

Dated: September 15, 2022

Conner Strong & Buckelew - Kate Kelly  
Consultant

By:



Brandon Pensick - Senior Vice President  
Title

10370 Commerce Center Drive Suite B200  
Address

Rancho Cucamonga CA 91730

EXHIBIT "E"

PUBLIC WORKS CONTRACTOR REGISTRATION CERTIFICATION

Pursuant to Labor Code sections 1725.5 and 1771.1, all contractors and subcontractors that wish to bid on, be listed in a bid proposal, or enter into a contract to perform public work must be registered with the Department of Industrial Relations. See <http://www.dir.ca.gov/Public-Works/PublicWorks.html> for additional information.

No bid will be accepted nor any contract entered into without proof of the contractor's and subcontractors' current registration with the Department of Industrial Relations to perform public work.

Contractor hereby certifies that it is aware of the registration requirements set forth in Labor Code sections 1725.5 and 1771.1 and is currently registered as a contractor with the Department of Industrial Relations.<sup>1</sup>

Name of Contractor: Ferreira Construction Co. Inc. dba  
Ferreira Coastal Construction Co.

DIR Registration Number: 1000001634

DIR Registration Expiration: 06.30.2023

Small Project Exemption:  Yes or  No

Unless Contractor is exempt pursuant to the small project exemption, Contractor further acknowledges:

- Contractor shall maintain a current DIR registration for the duration of the project.
- Contractor shall include the requirements of Labor Code sections 1725.5 and 1771.1 in its contract with subcontractors and ensure that all subcontractors are registered at the time of bid opening and maintain registration status for the duration of the project.
- Failure to submit this form or comply with any of the above requirements may result in a finding that the bid is non-responsive.

Name of Contractor Ferreira Construction Co. Inc. dba  
Ferreira Coastal Construction Co.

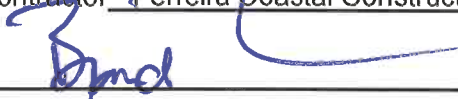
Signature 

Name and Title Brandon Pensick - Senior Vice President

Dated 09.15.2022

<sup>1</sup> If the Project is exempt from the contractor registration requirements pursuant to the small project exemption under Labor Code Sections 1725.5 and 1771.1, please mark "Yes" in response to "Small Project Exemption."

**EXHIBIT "F"**  
**PAYMENT AND PERFORMANCE BONDS**

**PERFORMANCE BOND**

KNOW ALL PERSONS BY THESE PRESENTS:

THAT WHEREAS, the City of San Clemente (hereinafter referred to as "City") has awarded to Ferreira Construction Co., Inc. dba Ferreira Coastal Construction Co., (hereinafter referred to as the "Contractor") 10370 Commerce Center Drive, Suite B-200 Rancho Cucamonga, CA 91730 an agreement for 216 LA Cuesta Sewer Repair and Manhole Construction (hereinafter referred to as the "Project").

WHEREAS, the work to be performed by the Contractor is more particularly set forth in the Contract Documents for the Project dated September 20, 2022 (hereinafter referred to as "Contract Documents"), the terms and conditions of which are expressly incorporated herein by reference; and

WHEREAS, the Contractor is required by said Contract Documents to perform the terms thereof and to furnish a bond for the faithful performance of said Contract Documents.

NOW, THEREFORE, we, Ferreira Construction Co., Inc. dba Ferreira Coastal Construction Co., the undersigned Contractor and Berkshire Hathaway Specialty Insurance Company as Surety, a corporation organized and duly authorized to transact business under the laws of the State of California, are held and firmly bound unto the City in the sum of Forty Three Thousand One Hundred Ninety Nine Dollars and 02/100 DOLLARS, (\$ 43,199.02), said sum being not less than one hundred percent (100%) of the total amount of the Contract, for which amount well and truly to be made, we bind ourselves, our heirs, executors and administrators, successors and assigns, jointly and severally, firmly by these presents.

THE CONDITION OF THIS OBLIGATION IS SUCH, that, if the Contractor, his or its heirs, executors, administrators, successors or assigns, shall in all things stand to and abide by, and well and truly keep and perform the covenants, conditions and agreements in the Contract Documents and any alteration thereof made as therein provided, on its part, to be kept and performed at the time and in the manner therein specified, and in all respects according to their intent and meaning; and shall faithfully fulfill all obligations including the one-year guarantee of all materials and workmanship; and shall indemnify and save harmless the City, its officers and agents, as stipulated in said Contract Documents, then this obligation shall become null and void; otherwise it shall be and remain in full force and effect.

As a condition precedent to the satisfactory completion of the Contract Documents, unless otherwise provided for in the Contract Documents, the above obligation shall hold good for a period of one (1) year after the acceptance of the work by City, during which time if Contractor shall fail to make full, complete, and satisfactory repair and replacements and totally protect the City from loss or damage resulting from or caused by defective materials or faulty workmanship, Surety shall undertake and faithfully fulfill all such obligations. The obligations of Surety hereunder shall continue so long as any obligation of Contractor remains. Nothing herein shall limit the City's rights or the Contractor or Surety's obligations under the Contract, law or equity, including, but not limited to, California Code of Civil Procedure section 337.15.

Whenever Contractor shall be, and is declared by the City to be, in default under the Contract Documents, the Surety shall remedy the default pursuant to the Contract Documents, or shall promptly, at the City's option:



- (1) Take over and complete the Project in accordance with all terms and conditions in the Contract Documents; or
- (2) Obtain a bid or bids for completing the Project in accordance with all terms and conditions in the Contract Documents and upon determination by Surety of the lowest responsive and responsible bidder, arrange for a Contract between such bidder, the Surety and the City, and make available as work progresses sufficient funds to pay the cost of completion of the Project, less the balance of the contract price, including other costs and damages for which Surety may be liable. The term "balance of the contract price" as used in this paragraph shall mean the total amount payable to Contractor by the City under the Contract and any modification thereto, less any amount previously paid by the City to the Contractor and any other set offs pursuant to the Contract Documents.
- (3) Permit the City to complete the Project in any manner consistent with local, California and federal law and make available as work progresses sufficient funds to pay the cost of completion of the Project, less the balance of the contract price, including other costs and damages for which Surety may be liable. The term "balance of the contract price" as used in this paragraph shall mean the total amount payable to Contractor by the City under the Contract and any modification thereto, less any amount previously paid by the City to the Contractor and any other set offs pursuant to the Contract Documents.

Surety expressly agrees that the City may reject any contractor or subcontractor which may be proposed by Surety in fulfillment of its obligations in the event of default by the Contractor.

Surety shall not utilize Contractor in completing the Project nor shall Surety accept a bid from Contractor for completion of the Project if the City, when declaring the Contractor in default, notifies Surety of the City's objection to Contractor's further participation in the completion of the Project.

The Surety, for value received, hereby stipulates and agrees that no change, extension of time, alteration or addition to the terms of the Contract Documents or to the Project to be performed thereunder shall in any way affect its obligations on this bond, and it does hereby waive notice of any such change, extension of time, alteration or addition to the terms of the Contract Documents or to the Project, including but not limited to the provisions of sections 2819 and 2845 of the California Civil Code.

IN WITNESS WHEREOF, we have hereunto set our hands and seals this 13th day of September, 2022 ).

(Corporate Seal)

Ferreira Construction Co., Inc. dba Ferreira Coastal Construction Co.

Contractor/Principal

By

Title Brandon Pensick

Senior Vice President

(Corporate Seal)

Berkshire Hathaway Specialty Insurance Company  
Surety

By  Krystal L. Stravato  
Attorney-in-Fact

Signatures of those signing for the Contractor and Surety must be notarized and evidence of corporate authority attached.

(Attach Attorney-in-Fact Certificate) Title Attorney-In-Fact

The rate of premium on this bond is \$6.25 per thousand. The total amount of premium charges, \$ 270.00.  
(The above must be filled in by corporate attorney.)

THIS IS A REQUIRED FORM

Any claims under this bond may be addressed to:

(Name and Address of Surety) Berkshire Hathaway Specialty Insurance Company  
1314 Douglas Street, Suite 1400  
Omaha, NE 68102 - 1944

(Name and Address of Agent or Representative for service of process in California, if different from above) \_\_\_\_\_  
\_\_\_\_\_

(Telephone number of Surety and Agent or Representative for service of process in California) (402) 916-3000

NOTE: A copy of the Power-of-Attorney authorizing the person signing on behalf of the Surety to do so must be attached hereto.

Please see Attached

### Notary Acknowledgment

A notary public or other officer completing this certificate verifies only the identity of the individual who signed the document to which this certificate is attached, and not the truthfulness, accuracy, or validity of that document.

STATE OF CALIFORNIA  
COUNTY OF \_\_\_\_\_

On \_\_\_\_\_, 20\_\_\_\_, before me, \_\_\_\_\_, Notary Public, personally

appeared \_\_\_\_\_, who proved to me on the basis of satisfactory evidence to be the person(s) whose name(s) is/are subscribed to the within instrument and acknowledged to me that he/she/they executed the same in his/her/their authorized capacity(ies), and that by his/her/their signature(s) on the instrument the person(s), or the entity upon behalf of which the person(s) acted, executed the instrument.

I certify under PENALTY OF PERJURY under the laws of the State of California that the foregoing paragraph is true and correct.

WITNESS my hand and official seal.

Signature of Notary Public

#### OPTIONAL

*Though the information below is not required by law, it may prove valuable to persons relying on the document and could prevent fraudulent removal and reattachment of this form to another document.*

#### CAPACITY CLAIMED BY SIGNER

#### DESCRIPTION OF ATTACHED DOCUMENT

- Individual
- Corporate Officer

Title(s)

Title or Type of Document

- Partner(s)
  - Limited
  - General

Number of Pages

- Attorney-In-Fact
- Trustee(s)
- Guardian/Conservator
- Other:

Date of Document

Signer is representing:  
Name Of Person(s) Or Entity(ies)

Signer(s) Other Than Named Above

**CALIFORNIA ALL-PURPOSE ACKNOWLEDGMENT**

**CIVIL CODE § 1189**

A notary public or other officer completing this certificate verifies only the identity of the individual who signed the document to which this certificate is attached, and not the truthfulness, accuracy, or validity of that document.

State of California )  
County of San Bernardino )

On September 15, 2022 before me, Marla K. Gibbins, Notary Public,  
*Date Here Insert Name and Title of the Officer*  
personally appeared Brandon Pensick  
*Name(s) of Signer(s)*

who proved to me on the basis of satisfactory evidence to be the person(s) whose name(s) is/are subscribed to the within instrument and acknowledged to me that he/she/they executed the same in his/her/their authorized capacity(ies), and that by his/her/their signature(s) on the instrument the person(s), or the entity upon behalf of which the person(s) acted, executed the instrument.

I certify under PENALTY OF PERJURY under the laws of the State of California that the foregoing paragraph is true and correct.

WITNESS my hand and official seal.

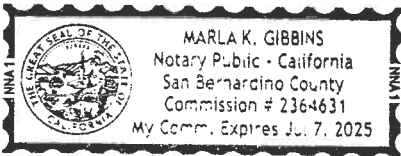

Signature Marla K. Gibbins  
*Signature of Notary Public*

*Place Notary Seal Above*

**OPTIONAL**

*Though this section is optional, completing this information can deter alteration of the document or fraudulent reattachment of this form to an unintended document.*

**Description of Attached Document**

Title or Type of Document: \_\_\_\_\_ Document Date: \_\_\_\_\_  
Number of Pages: \_\_\_\_\_ Signer(s) Other Than Named Above: \_\_\_\_\_

**Capacity(ies) Claimed by Signer(s)**

Signer's Name: \_\_\_\_\_  
 Corporate Officer — Title(s): \_\_\_\_\_  
 Partner —  Limited  General  
 Individual  Attorney in Fact  
 Trustee  Guardian or Conservator  
Other: \_\_\_\_\_  
Signer Is Representing: \_\_\_\_\_

Signer's Name: \_\_\_\_\_  
 Corporate Officer — Title(s): \_\_\_\_\_  
 Partner —  Limited  General  
 Individual  Attorney in Fact  
 Trustee  Guardian or Conservator  
Other: \_\_\_\_\_  
Signer Is Representing: \_\_\_\_\_

ACKNOWLEDGEMENT OF SURETY COMPANY

STATE OF NEW JERSEY

COUNTY OF MORRIS

ON THE 13<sup>th</sup> DAY OF September, 2022 BEFORE ME PERSONALLY APPEARED Krystal L. Stravato TO ME KNOWN, WHO BEING BY ME DULY SWORN, DID DEPOSE AND SAY; THAT (S)HE IS THE ATTORNEY-IN-FACT OF Berkshire Hathaway Specialty Insurance Company, THE CORPORATION THAT EXECUTED THE FOREGOING INSTRUMENT, AND ACKNOWLEDGED TO ME THAT SUCH CORPORATION EXECUTED THE SAME.

IN WITNESS WHEREOF, I HAVE HEREUNTO SET MY HAND AND AFFIXED MY OFFICIAL SEAL, AT MY OFFICE IN THE ABOVE COUNTY, THE DAY AND YEAR WRITTEN ABOVE.

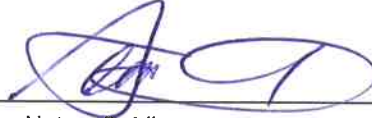

Notary Public

**Sandy S. James-Browne**  
Notary Public  
State of New Jersey  
My commission expires September 19, 2026

**Power Of Attorney**  
**BERKSHIRE HATHAWAY SPECIALTY INSURANCE COMPANY**  
**NATIONAL INDEMNITY COMPANY / NATIONAL LIABILITY & FIRE INSURANCE COMPANY**

Know all men by these presents, that **BERKSHIRE HATHAWAY SPECIALTY INSURANCE COMPANY**, a corporation existing under and by virtue of the laws of the State of Nebraska and having an office at One Lincoln Street, 23rd Floor, Boston, Massachusetts 02111, **NATIONAL INDEMNITY COMPANY**, a corporation existing under and by virtue of the laws of the State of Nebraska and having an office at 3024 Harney Street, Omaha, Nebraska 68131 and **NATIONAL LIABILITY & FIRE INSURANCE COMPANY**, a corporation existing under and by virtue of the laws of the State of Connecticut and having an office at 100 First Stamford Place, Stamford, Connecticut 06902 (hereinafter collectively the "Companies"), pursuant to and by the authority granted as set forth herein, do hereby name, constitute and appoint: **Krystal L. Stravato, Kevin T. Walsh, Jr., Thomas MacDonald, Jaclyn Thomas, 100 South Jefferson Road, Suite 101, of the city of Whippany, State of New Jersey**, their true and lawful attorney(s)-in-fact to make, execute, seal, acknowledge, and deliver, for and on their behalf as surety and as their act and deed, any and all undertakings, bonds, or other such writings obligatory in the nature thereof, in pursuance of these presents, the execution of which shall be as binding upon the Companies as if it has been duly signed and executed by their regularly elected officers in their own proper persons. **This authority for the Attorney-in-Fact shall be limited to the execution of the attached bond(s) or other such writings obligatory in the nature thereof.**

In witness whereof, this Power of Attorney has been subscribed by an authorized officer of the Companies, and the corporate seals of the Companies have been affixed hereto this date of December 20, 2018. This Power of Attorney is made and executed pursuant to and by authority of the Bylaws, Resolutions of the Board of Directors, and other Authorizations of **BERKSHIRE HATHAWAY SPECIALTY INSURANCE COMPANY, NATIONAL INDEMNITY COMPANY** and **NATIONAL LIABILITY & FIRE INSURANCE COMPANY**, which are in full force and effect, each reading as appears on the back page of this Power of Attorney, respectively. **The following signature by an authorized officer of the Company may be a facsimile, which shall be deemed the equivalent of and constitute the written signature of such officer of the Company for all purposes regarding this Power of Attorney, including satisfaction of any signature requirements on any and all undertakings, bonds, or other such writings obligatory in the nature thereof, to which this Power of Attorney applies.**

**BERKSHIRE HATHAWAY SPECIALTY INSURANCE COMPANY,**

By: \_\_\_\_\_  
David Fields, Executive Vice President



**NATIONAL INDEMNITY COMPANY,  
NATIONAL LIABILITY & FIRE INSURANCE COMPANY,**

By: \_\_\_\_\_  
David Fields, Vice President



**NOTARY**

State of Massachusetts, County of Suffolk, ss:

On this 20th day of December, 2018, before me appeared David Fields, Executive Vice President of **BERKSHIRE HATHAWAY SPECIALTY INSURANCE COMPANY** and Vice President of **NATIONAL INDEMNITY COMPANY** and **NATIONAL LIABILITY & FIRE INSURANCE COMPANY**, who being duly sworn, says that his capacity is as designated above for such Companies; that he knows the corporate seals of the Companies; that the seals affixed to the foregoing instrument are such corporate seals; that they were affixed by order of the board of directors or other governing body of said Companies pursuant to its Bylaws, Resolutions and other Authorizations, and that he signed said instrument in that capacity of said Companies.

[Notary Seal]

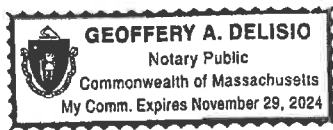

\_\_\_\_\_  
Notary Public

I, Ralph Tortorella, the undersigned, Officer of **BERKSHIRE HATHAWAY SPECIALTY INSURANCE COMPANY, NATIONAL INDEMNITY COMPANY** and **NATIONAL LIABILITY & FIRE INSURANCE COMPANY**, do hereby certify that the above and foregoing is a true and correct copy of the Power of Attorney executed by said Companies which is in full force and effect and has not been revoked. **IN TESTIMONY WHEREOF**, see hereunto affixed the seals of said Companies this **September 13, 2022**.



\_\_\_\_\_  
Officer

To verify the authenticity of this Power of Attorney please contact us at: BHSI Surety Department, Berkshire Hathaway Specialty Insurance Company, One Lincoln Street, 23rd Floor Boston, MA 02111 | (770) 625-2516 or by email at [jennifer.porter@bhspecialty.com](mailto:jennifer.porter@bhspecialty.com) THIS POWER OF ATTORNEY IS VOID IF ALTERED

To notify us of a claim please contact us on our 24-hour toll free number at (855) 453-9675, via email at [claimsnotice@bhspecialty.com](mailto:claimsnotice@bhspecialty.com), via fax to (617) 507-8259, or via mail.

**BERKSHIRE HATHAWAY SPECIALTY INSURANCE COMPANY (BYLAWS)**

ARTICLE V.

CORPORATE ACTIONS

....

EXECUTION OF DOCUMENTS:

....

Section 6.(b) The President, any Vice President or the Secretary, shall have the power and authority:

- (1) To appoint Attorneys-in-fact, and to authorize them to execute on behalf of the Company bonds and other undertakings, and
- (2) To remove at any time any such Attorney-in-fact and revoke the authority given him.

**NATIONAL INDEMNITY COMPANY (BY-LAWS)**

Section 4. Officers, Agents, and Employees:

A. The officers shall be a President, one or more Vice Presidents, a Secretary, one or more Assistant Secretaries, a Treasurer, and one or more Assistant Treasurers none of whom shall be required to be shareholders or Directors and each of whom shall be elected annually by the Board of Directors at each annual meeting to serve a term of office of one year or until a successor has been elected and qualified, may serve successive terms of office, may be removed from office at any time for or without cause by a vote of a majority of the Board of Directors, and shall have such powers and rights and be charged with such duties and obligations as usually are vested in and pertain to such office or as may be directed from time to time by the Board of Directors; and the Board of Directors or the officers may from time to time appoint, discharge, engage, or remove such agents and employees as may be appropriate, convenient, or necessary to the affairs and business of the corporation.

**NATIONAL INDEMNITY COMPANY (BOARD RESOLUTION ADOPTED AUGUST 6, 2014)**

RESOLVED, That the President, any Vice President or the Secretary, shall have the power and authority to (1) appoint Attorneys-in-fact, and to authorize them to execute on behalf of this Company bonds and other undertakings and (2) remove at any time any such Attorney-in-fact and revoke the authority given.

**NATIONAL LIABILITY & FIRE INSURANCE COMPANY (BY-LAWS)**

ARTICLE IV

Officers

Section 1. Officers, Agents and Employees:

A. The officers shall be a president, one or more vice presidents, one or more assistant vice presidents, a secretary, one or more assistant secretaries, a treasurer, and one or more assistant treasurers, none of whom shall be required to be shareholders or directors, and each of whom shall be elected annually by the board of directors at each annual meeting to serve a term of office of one year or until a successor has been elected and qualified, may serve successive terms of office, may be removed from office at any time for or without cause by a vote of a majority of the board of directors. The president and secretary shall be different individuals. Election or appointment of an officer or agent shall not create contract rights. The officers of the Corporation shall have such powers and rights and be charged with such duties and obligations as usually are vested in and pertain to such office or as may be directed from time to time by the board of directors; and the board of directors or the officers may from time to time appoint, discharge, engage, or remove such agents and employees as may be appropriate, convenient, or necessary to the affairs and business of the Corporation.

**NATIONAL LIABILITY & FIRE INSURANCE COMPANY (BOARD RESOLUTION ADOPTED AUGUST 6, 2014)**

RESOLVED, That the President, any Vice President or the Secretary, shall have the power and authority to (1) appoint Attorneys-in-fact, and to authorize them to execute on behalf of this Company bonds and other undertakings and (2) remove at any time any such Attorney-in-fact and revoke the authority given.

**BERKSHIRE HATHAWAY SPECIALTY  
INSURANCE COMPANY**

1314 Douglas Street, Suite 1400, Omaha, Nebraska 68102-1944

**ADMITTED ASSETS\***

	<u>12/31/2021</u>	<u>12/31/2020</u>	<u>12/31/2019</u>
Total invested assets	\$ 6,504,184,299	\$ 5,475,240,588	\$ 5,172,183,338
Premium & agent balances (n)	552,510,359	603,615,506	368,086,012
All other assets	142,765,038	157,897,676	127,524,677
<b>Admitted Assets</b>	<u>\$ 7,199,459,696</u>	<u>\$ 6,236,753,770</u>	<u>\$ 5,667,794,027</u>

**LIABILITIES & SURPLUS\***

	<u>12/31/2021</u>	<u>12/31/2020</u>	<u>12/31/2019</u>
Loss & loss exp. unpaid	\$ 1,142,116,028	\$ 921,923,948	\$ 634,745,558
Unearned premiums	484,660,143	372,836,160	314,117,549
All other liabilities	1,163,007,684	1,054,922,210	744,738,458
<b>Total Liabilities</b>	<u>2,789,783,855</u>	<u>2,349,682,318</u>	<u>1,693,601,565</u>
<b>Total Policyholders' Surplus</b>	<u>4,409,675,842</u>	<u>3,887,071,452</u>	<u>3,974,192,463</u>
<b>Total Liabilities &amp; Surplus</b>	<u>\$ 7,199,459,697</u>	<u>\$ 6,236,753,770</u>	<u>\$ 5,667,794,028</u>

\* Assets, liabilities and surplus are presented on a Statutory Accounting Basis as promulgated by the NAIC and/or the laws of the company's domiciliary state.



**PAYMENT BOND**

KNOW ALL MEN BY THESE PRESENTS That

WHEREAS, the City of San Clemente (hereinafter designated as the "City") by action taken or a resolution passed September 20, 2022 has awarded to Ferreira Construction Co., Inc. dba Ferreira Coastal Construction Co. hereinafter designated as the "Principal," a contract for the work described as follows:

216 LA Cuesta Sewer Repair and Manhole Construction (the "Project"); and

WHEREAS, the work to be performed by the Principal is more particularly set forth in the Contract Documents for the Project dated September 20, 2022 ("Contract Documents"), the terms and conditions of which are expressly incorporated by reference; and

WHEREAS, said Principal is required to furnish a bond in connection with said contract; providing that if said Principal or any of its Subcontractors shall fail to pay for any materials, provisions, provender, equipment, or other supplies used in, upon, for or about the performance of the work contracted to be done, or for any work or labor done thereon of any kind, or for amounts due under the Unemployment Insurance Code or for any amounts required to be deducted, withheld, and paid over to the Employment Development Department from the wages of employees of said Principal and its Subcontractors with respect to such work or labor the Surety on this bond will pay for the same to the extent hereinafter set forth.

NOW THEREFORE, we, the Principal and Berkshire Hathaway Specialty Insurance Company as Surety, are held and firmly bound unto the City in the penal sum of Forty Three Thousand One Hundred Ninety Nine Dollars and 02/100 Dollars (\$ 43,199.02 ) lawful money of the United States of America, for the payment of which sum well and truly to be made, we bind ourselves, our heirs, executors, administrators, successors and assigns, jointly and severally, firmly by these presents.

THE CONDITION OF THIS OBLIGATION IS SUCH that if said Principal, his or its subcontractors, heirs, executors, administrators, successors or assigns, shall fail to pay any of the persons named in Section 9100 of the Civil Code, fail to pay for any materials, provisions or other supplies, used in, upon, for or about the performance of the work contracted to be done, or for any work or labor thereon of any kind, or amounts due under the Unemployment Insurance Code with respect to work or labor performed under the contract, or for any amounts required to be deducted, withheld, and paid over to the Employment Development Department or Franchise Tax Board from the wages of employees of the contractor and his subcontractors pursuant to Section 18663 of the Revenue and Taxation Code, with respect to such work and labor the Surety or Sureties will pay for the same, in an amount not exceeding the sum herein above specified.

This bond shall inure to the benefit of any of the persons named in Section 9100 of the Civil Code so as to give a right of action to such persons or their assigns in any suit brought upon this bond.

It is further stipulated and agreed that the Surety on this bond shall not be exonerated or released from the obligation of this bond by any change, extension of time for performance, addition, alteration or modification in, to, or of any contract, plans, specifications, or agreement pertaining or relating to any scheme or work of improvement herein above described, or pertaining or relating to the furnishing of labor, materials, or equipment therefore, nor by any change or modification of any terms of payment or extension of the time for any payment pertaining or relating to any scheme or work of improvement herein above described, nor by any rescission or attempted rescission of the contract, agreement or bond, nor by any conditions precedent or

subsequent in the bond attempting to limit the right of recovery of claimants otherwise entitled to recover under any such contract or agreement or under the bond, nor by any fraud practiced by any person other than the claimant seeking to recover on the bond and that this bond be construed most strongly against the Surety and in favor of all persons for whose benefit such bond is given, and under no circumstances shall Surety be released from liability to those for whose benefit such bond has been given, by reason of any breach of contract between the owner or City and original contractor or on the part of any obligee named in such bond, but the sole conditions of recovery shall be that claimant is a person described in Section 9100 of the Civil Code, and has not been paid the full amount of his claim and that Surety does hereby waive notice of any such change, extension of time, addition, alteration or modification herein mentioned and the provisions of sections 2819 and 2845 of the California Civil Code.

IN WITNESS WHEREOF, we have hereunto set our hands and seals this 13th day of September, 2022.

(Corporate Seal)

Ferreira Construction Co., Inc. dba Ferreira Coastal Construction Co.

Contractor/ Principal

By [Signature]

Title Brandon Pensick-Senior Vice President

(Corporate Seal)

Berkshire Hathaway Specialty Insurance Company

Surety

By [Signature] Krystal L. Stravato

Attorney-in-Fact

Title Attorney-In-Fact

Signatures of those signing for the Contractor and Surety must be notarized and evidence of corporate authority attached. A Power-of-Attorney authorizing the person signing on behalf of the Surety to do so must be attached hereto.

NOTE: A copy of the Power-of-Attorney authorizing the person signing on behalf of the Surety to do so must be attached hereto.

Please see Attached

### Notary Acknowledgment

A notary public or other officer completing this certificate verifies only the identity of the individual who signed the document to which this certificate is attached, and not the truthfulness, accuracy, or validity of that document.

STATE OF CALIFORNIA  
COUNTY OF \_\_\_\_\_

On \_\_\_\_\_, 20\_\_\_\_, before me, \_\_\_\_\_, Notary Public, personally appeared \_\_\_\_\_, who proved to me on the basis of satisfactory

evidence to be the person(s) whose name(s) is/are subscribed to the within instrument and acknowledged to me that he/she/they executed the same in his/her/their authorized capacity(ies), and that by his/her/their signature(s) on the instrument the person(s), or the entity upon behalf of which the person(s) acted, executed the instrument.

I certify under PENALTY OF PERJURY under the laws of the State of California that the foregoing paragraph is true and correct.

WITNESS my hand and official seal.

Signature of Notary Public

\_\_\_\_\_

#### OPTIONAL

*Though the information below is not required by law, it may prove valuable to persons relying on the document and could prevent fraudulent removal and reattachment of this form to another document.*

#### CAPACITY CLAIMED BY SIGNER

#### DESCRIPTION OF ATTACHED DOCUMENT

- Individual
- Corporate Officer

\_\_\_\_\_ Title(s)

\_\_\_\_\_ Title or Type of Document

- Partner(s)
  - Limited
  - General

\_\_\_\_\_ Number of Pages

- Attorney-In-Fact
- Trustee(s)
- Guardian/Conservator
- Other:

\_\_\_\_\_ Date of Document

Signer is representing:  
Name Of Person(s) Or Entity(ies)

\_\_\_\_\_  
\_\_\_\_\_

\_\_\_\_\_ Signer(s) Other Than Named Above

**CALIFORNIA ALL-PURPOSE ACKNOWLEDGMENT**

**CIVIL CODE § 1189**

A notary public or other officer completing this certificate verifies only the identity of the individual who signed the document to which this certificate is attached, and not the truthfulness, accuracy, or validity of that document.

State of California )  
County of San Bernardino )

On September 15, 2022 before me, Marla K. Gibbins, Notary Public,  
*Date Here Insert Name and Title of the Officer*  
personally appeared Brandon Pensick  
*Name(s) of Signer(s)*

who proved to me on the basis of satisfactory evidence to be the person(s) whose name(s) is/are subscribed to the within instrument and acknowledged to me that he/she/they executed the same in his/her/their authorized capacity(ies), and that by his/her/their signature(s) on the instrument the person(s), or the entity upon behalf of which the person(s) acted, executed the instrument.

I certify under PENALTY OF PERJURY under the laws of the State of California that the foregoing paragraph is true and correct.

WITNESS my hand and official seal.

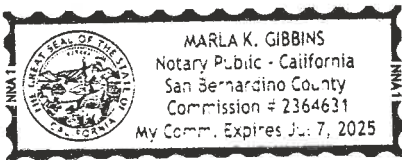

Signature Marla K. Gibbins  
*Signature of Notary Public*

*Place Notary Seal Above*

**OPTIONAL**

*Though this section is optional, completing this information can deter alteration of the document or fraudulent reattachment of this form to an unintended document.*

**Description of Attached Document**

Title or Type of Document: \_\_\_\_\_ Document Date: \_\_\_\_\_

Number of Pages: \_\_\_\_\_ Signer(s) Other Than Named Above: \_\_\_\_\_

**Capacity(ies) Claimed by Signer(s)**

Signer's Name: \_\_\_\_\_  
 Corporate Officer — Title(s): \_\_\_\_\_  
 Partner —  Limited  General  
 Individual  Attorney in Fact  
 Trustee  Guardian or Conservator  
 Other: \_\_\_\_\_

Signer Is Representing: \_\_\_\_\_

Signer's Name: \_\_\_\_\_  
 Corporate Officer — Title(s): \_\_\_\_\_  
 Partner —  Limited  General  
 Individual  Attorney in Fact  
 Trustee  Guardian or Conservator  
 Other: \_\_\_\_\_

Signer Is Representing: \_\_\_\_\_

ACKNOWLEDGEMENT OF SURETY COMPANY

STATE OF NEW JERSEY

COUNTY OF MORRIS

ON THE 13<sup>th</sup> DAY OF September, 2022 BEFORE ME PERSONALLY APPEARED Krystal L. Stravato TO ME KNOWN, WHO BEING BY ME DULY SWORN, DID DEPOSE AND SAY; THAT (S)HE IS THE ATTORNEY-IN-FACT OF Berkshire Hathaway Specialty Insurance Company, THE CORPORATION THAT EXECUTED THE FOREGOING INSTRUMENT, AND ACKNOWLEDGED TO ME THAT SUCH CORPORATION EXECUTED THE SAME.

IN WITNESS WHEREOF, I HAVE HEREUNTO SET MY HAND AND AFFIXED MY OFFICIAL SEAL, AT MY OFFICE IN THE ABOVE COUNTY, THE DAY AND YEAR WRITTEN ABOVE.



Notary Public

**Sandy S. James-Browne**  
Notary Public  
State of New Jersey  
My commission expires September 19, 2026



Power Of Attorney

BERKSHIRE HATHAWAY SPECIALTY INSURANCE COMPANY NATIONAL INDEMNITY COMPANY / NATIONAL LIABILITY & FIRE INSURANCE COMPANY

Know all men by these presents, that BERKSHIRE HATHAWAY SPECIALTY INSURANCE COMPANY, a corporation existing under and by virtue of the laws of the State of Nebraska and having an office at One Lincoln Street, 23rd Floor, Boston, Massachusetts 02111, NATIONAL INDEMNITY COMPANY, a corporation existing under and by virtue of the laws of the State of Nebraska and having an office at 3024 Harney Street, Omaha, Nebraska 68131 and NATIONAL LIABILITY & FIRE INSURANCE COMPANY, a corporation existing under and by virtue of the laws of the State of Connecticut and having an office at 100 First Stamford Place, Stamford, Connecticut 06902 (hereinafter collectively the "Companies"), pursuant to and by the authority granted as set forth herein, do hereby name, constitute and appoint: Krystal L. Stravato, Kevin T. Walsh, Jr., Thomas MacDonald, Jaclyn Thomas, 100 South Jefferson Road, Suite 101, of the city of Whippany, State of New Jersey, their true and lawful attorney(s)-in-fact to make, execute, seal, acknowledge, and deliver, for and on their behalf as surety and as their act and deed, any and all undertakings, bonds, or other such writings obligatory in the nature thereof, in pursuance of these presents, the execution of which shall be as binding upon the Companies as if it has been duly signed and executed by their regularly elected officers in their own proper persons. This authority for the Attorney-in-Fact shall be limited to the execution of the attached bond(s) or other such writings obligatory in the nature thereof.

In witness whereof, this Power of Attorney has been subscribed by an authorized officer of the Companies, and the corporate seals of the Companies have been affixed hereto this date of December 20, 2018. This Power of Attorney is made and executed pursuant to and by authority of the Bylaws, Resolutions of the Board of Directors, and other Authorizations of BERKSHIRE HATHAWAY SPECIALTY INSURANCE COMPANY, NATIONAL INDEMNITY COMPANY and NATIONAL LIABILITY & FIRE INSURANCE COMPANY, which are in full force and effect, each reading as appears on the back page of this Power of Attorney, respectively. The following signature by an authorized officer of the Company may be a facsimile, which shall be deemed the equivalent of and constitute the written signature of such officer of the Company for all purposes regarding this Power of Attorney, including satisfaction of any signature requirements on any and all undertakings, bonds, or other such writings obligatory in the nature thereof, to which this Power of Attorney applies.

BERKSHIRE HATHAWAY SPECIALTY INSURANCE COMPANY,

[Signature of David Fields]

By:

David Fields, Executive Vice President



NATIONAL INDEMNITY COMPANY, NATIONAL LIABILITY & FIRE INSURANCE COMPANY,

[Signature of David Fields]

By:

David Fields, Vice President



NOTARY

State of Massachusetts, County of Suffolk, ss:

On this 20th day of December, 2018, before me appeared David Fields, Executive Vice President of BERKSHIRE HATHAWAY SPECIALTY INSURANCE COMPANY and Vice President of NATIONAL INDEMNITY COMPANY and NATIONAL LIABILITY & FIRE INSURANCE COMPANY, who being duly sworn, says that his capacity is as designated above for such Companies; that he knows the corporate seals of the Companies; that the seals affixed to the foregoing instrument are such corporate seals; that they were affixed by order of the board of directors or other governing body of said Companies pursuant to its Bylaws, Resolutions and other Authorizations, and that he signed said instrument in that capacity of said Companies.

[Notary Seal]

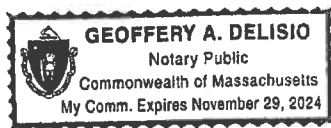

[Signature of Notary Public]

Notary Public

I, Ralph Tortorella, the undersigned, Officer of BERKSHIRE HATHAWAY SPECIALTY INSURANCE COMPANY, NATIONAL INDEMNITY COMPANY and NATIONAL LIABILITY & FIRE INSURANCE COMPANY, do hereby certify that the above and foregoing is a true and correct copy of the Power of Attorney executed by said Companies which is in full force and effect and has not been revoked. IN TESTIMONY WHEREOF, see hereunto affixed the seals of said Companies this September 13, 2022.



[Signature of Officer]

Officer

To verify the authenticity of this Power of Attorney please contact us at: BHS Surety Department, Berkshire Hathaway Specialty Insurance Company, One Lincoln Street, 23rd Floor Boston, MA 02111 | (770) 625-2516 or by email at Jennifer.Porter@bhspecialty.com THIS POWER OF ATTORNEY IS VOID IF ALTERED

To notify us of a claim please contact us on our 24-hour toll free number at (855) 453-9675, via email at claimsnotice@bhspecialty.com, via fax to (617) 507-8259, or via mail.



**BERKSHIRE HATHAWAY SPECIALTY INSURANCE COMPANY (BYLAWS)**

ARTICLE V.

CORPORATE ACTIONS

....

EXECUTION OF DOCUMENTS:

....

Section 6.(b) The President, any Vice President or the Secretary, shall have the power and authority:

- (1) To appoint Attorneys-in-fact, and to authorize them to execute on behalf of the Company bonds and other undertakings, and
- (2) To remove at any time any such Attorney-in-fact and revoke the authority given him.

**NATIONAL INDEMNITY COMPANY (BY-LAWS)**

Section 4. Officers, Agents, and Employees:

A. The officers shall be a President, one or more Vice Presidents, a Secretary, one or more Assistant Secretaries, a Treasurer, and one or more Assistant Treasurers none of whom shall be required to be shareholders or Directors and each of whom shall be elected annually by the Board of Directors at each annual meeting to serve a term of office of one year or until a successor has been elected and qualified, may serve successive terms of office, may be removed from office at any time for or without cause by a vote of a majority of the Board of Directors, and shall have such powers and rights and be charged with such duties and obligations as usually are vested in and pertain to such office or as may be directed from time to time by the Board of Directors; and the Board of Directors or the officers may from time to time appoint, discharge, engage, or remove such agents and employees as may be appropriate, convenient, or necessary to the affairs and business of the corporation.

**NATIONAL INDEMNITY COMPANY (BOARD RESOLUTION ADOPTED AUGUST 6, 2014)**

RESOLVED, That the President, any Vice President or the Secretary, shall have the power and authority to (1) appoint Attorneys-in-fact, and to authorize them to execute on behalf of this Company bonds and other undertakings and (2) remove at any time any such Attorney-in-fact and revoke the authority given.

**NATIONAL LIABILITY & FIRE INSURANCE COMPANY (BY-LAWS)**

ARTICLE IV

Officers

Section 1. Officers, Agents and Employees:

A. The officers shall be a president, one or more vice presidents, one or more assistant vice presidents, a secretary, one or more assistant secretaries, a treasurer, and one or more assistant treasurers, none of whom shall be required to be shareholders or directors, and each of whom shall be elected annually by the board of directors at each annual meeting to serve a term of office of one year or until a successor has been elected and qualified, may serve successive terms of office, may be removed from office at any time for or without cause by a vote of a majority of the board of directors. The president and secretary shall be different individuals. Election or appointment of an officer or agent shall not create contract rights. The officers of the Corporation shall have such powers and rights and be charged with such duties and obligations as usually are vested in and pertain to such office or as may be directed from time to time by the board of directors; and the board of directors or the officers may from time to time appoint, discharge, engage, or remove such agents and employees as may be appropriate, convenient, or necessary to the affairs and business of the Corporation.

**NATIONAL LIABILITY & FIRE INSURANCE COMPANY (BOARD RESOLUTION ADOPTED AUGUST 6, 2014)**

RESOLVED, That the President, any Vice President or the Secretary, shall have the power and authority to (1) appoint Attorneys-in-fact, and to authorize them to execute on behalf of this Company bonds and other undertakings and (2) remove at any time any such Attorney-in-fact and revoke the authority given.

**BERKSHIRE HATHAWAY SPECIALTY  
INSURANCE COMPANY**

1314 Douglas Street, Suite 1400, Omaha, Nebraska 68102-1944

**ADMITTED ASSETS \***

	<u>12/31/2021</u>	<u>12/31/2020</u>	<u>12/31/2019</u>
Total invested assets	\$ 6,504,184,299	\$ 5,475,240,588	\$ 5,172,183,338
Premium & agent balances (n)	552,510,359	603,615,506	368,086,012
All other assets	142,765,038	157,897,676	127,524,677
<b>Admitted Assets</b>	<u>\$ 7,199,459,696</u>	<u>\$ 6,236,753,770</u>	<u>\$ 5,667,794,027</u>

**LIABILITIES & SURPLUS \***

	<u>12/31/2021</u>	<u>12/31/2020</u>	<u>12/31/2019</u>
Loss & loss exp. unpaid	\$ 1,142,116,028	\$ 921,923,948	\$ 634,745,558
Unearned premiums	484,660,143	372,836,160	314,117,549
All other liabilities	1,163,007,684	1,054,922,210	744,738,458
<b>Total Liabilities</b>	<u>2,789,783,855</u>	<u>2,349,682,318</u>	<u>1,693,601,565</u>
<b>Total Policyholders' Surplus</b>	<u>4,409,675,842</u>	<u>3,887,071,452</u>	<u>3,974,192,463</u>
<b>Total Liabilities &amp; Surplus</b>	<u>\$ 7,199,459,697</u>	<u>\$ 6,236,753,770</u>	<u>\$ 5,667,794,028</u>

\* Assets, liabilities and surplus are presented on a Statutory Accounting Basis as promulgated by the NAIC and/or the laws of the company's domiciliary state.



**EXHIBIT "G"**  
**FEDERAL REQUIREMENTS**

**(NOT APPLICABLE)**

## EXHIBIT "H"

### INSURANCE REQUIREMENTS

#### 3.13 Insurance.

3.13.1 Time for Compliance. Contractor shall not commence work under this Contract until it has provided evidence satisfactory to the City that it has secured all insurance required under this section. In addition, Contractor shall not allow any subcontractor to commence work on any subcontract as required in section 1.1.12 of this agreement.

3.13.2 Types of Insurance Required. As a condition precedent to the effectiveness of this Contract for work to be performed hereunder, and without limiting the indemnity provisions of the Contract, the Contractor, in partial performance of its obligations under such Contract, shall procure and maintain in full force and effect during the term of the Contract the following policies of insurance. If the existing policies do not meet the insurance requirements set forth herein, Contractor agrees to amend, supplement or endorse the policies to do so.

(A) Commercial General Liability: Commercial General Liability Insurance which affords coverage at least as broad as Insurance Services Office "occurrence" form CG 0001, or the exact equivalent, and shall be no less than \$1,000,000 per occurrence and no less than \$2,000,000 in the general aggregate. Defense costs shall be paid in addition to the limits. The policy shall contain no endorsements or provisions limiting coverage for (1) contractual liability; (2) cross liability exclusion for claims or suits by one insured against another; or (3) contain any other exclusion contrary to the Contract.

(B) Automobile Liability Insurance: Automobile Liability Insurance with coverage at least as broad as Insurance Services Office Form CA 0001 covering "Any Auto" (Symbol 1), or the exact equivalent, covering bodily injury and property damage for all activities shall be in an amount of not less than \$1,000,000 combined limit for each occurrence.

(C) Workers' Compensation: Workers' Compensation Insurance, as required by the State of California and Employer's Liability Insurance with a limit of not less than \$1,000,000 per accident for bodily injury and disease.

(D) Builder's Risk Insurance ["All Risk"]: Not Required.

(E) Contractors Pollution Liability: Not Used.

3.13.3 Endorsements. Required insurance policies shall contain the following provisions, or Contractor shall provide endorsements on forms approved by the City to add the following provisions to the insurance policies:

(A) Commercial General Liability

(1) Additional Insured: The City, its officials, officers, employees, agents, and volunteers shall be additional insureds with regard to liability and defense of suits or claims arising out of the performance of the Contract.

Additional Insured Endorsements shall not (1) be restricted to "ongoing operations"; (2) exclude "contractual liability"; (3) restrict coverage to "sole" liability of Contractor; or (4) contain any other exclusions contrary to the terms of purposes of this Contract. For all policies of Commercial General Liability insurance, Contractor shall provide endorsements in the form of ISO CG 20 10 10 01 and 20 37 10 01 (or endorsements providing the exact same coverage) to effectuate this requirement.

(2) Cancellation: Required insurance policies shall not be canceled or the coverage reduced until a thirty (30) day written notice of cancellation has been served upon the City except ten (10) days shall be allowed for non-payment of premium.

(B) Automobile Liability:

(1) Cancellation: Required insurance policies shall not be canceled or the coverage reduced until a thirty (30) day written notice of cancellation has been served upon the City except ten (10) days shall be allowed for non-payment of premium.

(C) Workers' Compensation:

(1) Waiver of Subrogation: A waiver of subrogation stating that the insurer waives all rights of subrogation against the City, its officials, officers, employees, agents and volunteers.

(2) Cancellation: Required insurance policies shall not be canceled or the coverage reduced until a thirty (30) day written notice of cancellation has been served upon the City except ten (10) days shall be allowed for non-payment of premium.

3.13.4 Primary and Non-Contributing Insurance. All policies of Commercial General Liability, Automobile Liability insurance (if required) shall be primary and any other insurance, deductible, or self-insurance maintained by the City, its officials, officers, employees agents or volunteers shall not contribute with this primary insurance. Policies shall contain or be endorsed to contain such provisions.

3.13.5 Waiver of Subrogation. All policies of Commercial General Liability, Automobile Liability insurance (if required) shall contain or be endorsed to waive subrogation against the City, its officials, officers, employees, agents, and volunteers or shall specifically allow Contractor or others providing insurance evidence in compliance with these specifications to waive their right of recovery prior to a loss. Contractor hereby waives its own right of recovery against City, and shall require similar written express waivers and insurance clauses from each of its subcontractors.

3.13.6 Deductibles and Self-Insured Retentions. Any deductible or self-insured retention in excess of \$5,000 must be approved in writing by the City and shall protect the City, its officials, officers, employees, agents and volunteers in the same manner and to the same extent as they would have been protected had the policy or policies not contained a deductible or self-insured retention.

3.13.7 Evidence of Insurance. The Contractor, concurrently with the execution of the Contract, and as a condition precedent to the effectiveness thereof, shall deliver either certified copies of the required policies, or original certificates on forms approved by the City, together with

all endorsements affecting each policy. Required insurance policies shall not be in compliance if they include any limiting provision or endorsement that has not been submitted to the City for approval. The certificates and endorsements for each insurance policy shall be signed by a person authorized by that insurer to bind coverage on its behalf. At least fifteen (15 days) prior to the expiration of any such policy, evidence of insurance showing that such insurance coverage has been renewed or extended shall be filed with the City. If such coverage is cancelled or reduced, and not replaced immediately so as to avoid a lapse in the required coverage, Contractor shall, within ten (10) days after receipt of written notice of such cancellation or reduction of coverage, file with the City evidence of insurance showing that the required insurance has been reinstated or has been provided through another insurance company or companies.

3.13.8 Failure to Maintain Coverage. In the event any policy of insurance required under this Contract does not comply with these specifications or is canceled and not replaced immediately so as to avoid a lapse in the required coverage, City has the right but not the duty to obtain the insurance it deems necessary and any premium paid by City will be promptly reimbursed by Contractor or City will withhold amounts sufficient to pay premium from Contractor payments. In the alternative, City may cancel this Contract, effective upon notice.

3.13.9 Acceptability of Insurers. Each such policy shall be from a company or companies with a current A.M. Best's rating of no less than A- VII and authorized to transact business of insurance in the State of California, or otherwise allowed to place insurance through surplus line brokers under applicable provisions of the California Insurance Code or any federal law.

3.13.10 Enforcement of Contract Provisions (non estoppel). Contractor acknowledges and agrees that actual or alleged failure on the part of the City to inform Contractor of non-compliance with any requirement imposes no additional obligation on the City nor does it waive any rights hereunder.

3.13.11 Requirements Not Limiting. Requirement of specific coverage or minimum limits contained in this Appendix are not intended as a limitation on coverage, limits, or other requirement, or a waiver of any coverage normally provided by any insurance.

3.13.12 Insurance for Subcontractors. Contractor shall include all Subcontractors as additional insureds under the Contractor's policies, or the Contractor shall be responsible for causing Subcontractors to purchase the appropriate insurance in compliance with the terms of these Insurance Requirements, including adding the City, its officials, officers, employees, agents and volunteers as additional insureds to the Subcontractor's policies. All policies of Commercial General Liability insurance provided by Subcontractors shall be endorsed to name the City, its officials, officers, employees, agents and volunteers as additional insureds using endorsement form ISO CG 20 38 04 13. Contractor shall not allow any Subcontractor to commence work until it has received satisfactory evidence of Subcontractor's compliance with all insurance requirements under this Contract, to the extent applicable. The Contractor shall provide satisfactory evidence of compliance with this section upon request of the City.



## DESCRIPTIONS (Continued from Page 1)

Company)

Coverage: Excess Liability (4th Layer - \$5M x \$8M)

Carrier: Evanston Insurance Company (NAIC#: 35378)

Policy Term: 07/01/2022 to 07/01/2023

Policy #: MKLV7EUE100768

Limits: \$2,500,000 Per Occurrence / Aggregate (part of \$5,000,000 Quota Share with Colony Insurance Company)

Coverage: Excess Liability (5th Layer - \$12M x \$13M)

Carrier: Navigators Insurance Company (NAIC#: 42307)

Policy Term: 07/01/2022 to 07/01/2023

Policy #: NY22EXCZ02BJWIV

Limits: \$12,000,000 Per Occurrence / Aggregate

RE: FCC Job #5391, 216 La Cuesta Sewer Repair and Manhole Construction

Location: 216 Avenida La Cuesta, San Clemente

The City, its officials, officers, employees, agents, and volunteers are Additional Insureds on the above referenced General Liability and Automobile Liability Policies, but only to the extent if required by written contract and provided in the Additional Insured Endorsement attached to the policy, a copy of which is available upon request.

General Liability and Automobile Liability Policies will pay for covered loss on a primary basis and the Insurance Company will not seek contribution from the Certificate Holder for such loss until the Insurance Carriers primary limits of liability have been exhausted.

Where permitted by state law, the insurer waives its right to subrogate against the Certificate Holder by reason of payments made under General Liability, Automobile Liability, and Workers Compensation Policies, but only under the circumstances stated in the policy.

**THIS ENDORSEMENT CHANGES THE POLICY. PLEASE READ IT CAREFULLY.**

**ADDITIONAL INSURED – OWNERS, LESSEES OR CONTRACTORS – COMPLETED OPERATIONS**

This endorsement modifies insurance provided under the following:

COMMERCIAL GENERAL LIABILITY COVERAGE PART  
PRODUCTS/COMPLETED OPERATIONS LIABILITY COVERAGE PART

**SCHEDULE**

Name Of Additional Insured Person(s) Or Organization(s)	Location And Description Of Completed Operations
All persons or organizations as required by written contract or agreement, prior to an "occurrence" or offence, to provide additional insured status	Per the contract or agreement
Information required to complete this Schedule, if not shown above, will be shown in the Declarations.	

**A. Section II – Who Is An Insured** is amended to include as an additional insured the person(s) or organization(s) shown in the Schedule, but only with respect to liability for "bodily injury" or "property damage" caused, in whole or in part, by "your work" at the location designated and described in the Schedule of this endorsement performed for that additional insured and included in the "products-completed operations hazard".

However:

1. The insurance afforded to such additional insured only applies to the extent permitted by law; and
2. If coverage provided to the additional insured is required by a contract or agreement, the insurance afforded to such additional insured will not be broader than that which you are required by the contract or agreement to provide for such additional insured.

**B.** With respect to the insurance afforded to these additional insureds, the following is added to **Section III – Limits Of Insurance:**

If coverage provided to the additional insured is required by a contract or agreement, the most we will pay on behalf of the additional insured is the amount of insurance:

1. Required by the contract or agreement; or
  2. Available under the applicable limits of insurance;
- whichever is less.

This endorsement shall not increase the applicable limits of insurance.



**THIS ENDORSEMENT CHANGES THE POLICY. PLEASE READ IT CAREFULLY.**

**ADDITIONAL INSURED – OWNERS, LESSEES OR CONTRACTORS – SCHEDULED PERSON OR ORGANIZATION**

This endorsement modifies insurance provided under the following:

COMMERCIAL GENERAL LIABILITY COVERAGE PART

**SCHEDULE**

Name Of Additional Insured Person(s) Or Organization(s)	Location(s) Of Covered Operations
All persons or organizations as required by written contract or agreement, prior to an "occurrence" or offence, to provide additional insured status	Per the contract or agreement
Information required to complete this Schedule, if not shown above, will be shown in the Declarations.	

**A. Section II – Who Is An Insured** is amended to include as an additional insured the person(s) or organization(s) shown in the Schedule, but only with respect to liability for "bodily injury", "property damage" or "personal and advertising injury" caused, in whole or in part, by:

1. Your acts or omissions; or
2. The acts or omissions of those acting on your behalf;

in the performance of your ongoing operations for the additional insured(s) at the location(s) designated above.

However:

1. The insurance afforded to such additional insured only applies to the extent permitted by law; and
2. If coverage provided to the additional insured is required by a contract or agreement, the insurance afforded to such additional insured will not be broader than that which you are required by the contract or agreement to provide for such additional insured.

**B. With respect to the insurance afforded to these additional insureds, the following additional exclusions apply:**

This insurance does not apply to "bodily injury" or "property damage" occurring after:

1. All work, including materials, parts or equipment furnished in connection with such work, on the project (other than service, maintenance or repairs) to be performed by or on behalf of the additional insured(s) at the location of the covered operations has been completed; or
2. That portion of "your work" out of which the injury or damage arises has been put to its intended use by any person or organization other than another contractor or subcontractor engaged in performing operations for a principal as a part of the same project.

C. With respect to the insurance afforded to these additional insureds, the following is added to **Section III – Limits Of Insurance:**

If coverage provided to the additional insured is required by a contract or agreement, the most we will pay on behalf of the additional insured is the amount of insurance:

1. Required by the contract or agreement; or

2. Available under the applicable limits of insurance;  
whichever is less.

This endorsement shall not increase the applicable limits of insurance.

Policy Number TB2-631-510814-022  
Issued by Liberty Mutual Fire Insurance Co

**THIS ENDORSEMENT CHANGES THE POLICY. PLEASE READ IT CAREFULLY.**

**OTHER INSURANCE AMENDMENT – SCHEDULED ADDITIONAL INSURED**

This endorsement modifies insurance provided under the following:

COMMERCIAL GENERAL LIABILITY COVERAGE PART  
PRODUCTS/COMPLETED OPERATIONS LIABILITY COVERAGE PART  
LIQUOR LIABILITY COVERAGE PART

**Schedule**

**Name of Person(s) or Organization(s):** Any person(s) or Organization(s) to whom you are Obligated by a written agreement to procure additional insured coverage under your policy

If you are obligated under a written agreement to provide liability insurance on a primary, excess, contingent, or any other basis for any person(s) or organization(s) shown in the Schedule of this endorsement that qualifies as an additional insured on this Policy, this Policy will apply solely on the basis required by such written agreement and Paragraph 4. Other Insurance of Section IV – Conditions will not apply. Where the applicable written agreement does not specify on what basis the liability insurance will apply, the provisions of Paragraph 4. Other Insurance of Section IV – Conditions will apply. However, this insurance is excess over any other insurance available to the additional insured for which it is also covered as an additional insured for the same "occurrence", claim or "suit".

## WAIVER OF TRANSFER OF RIGHTS OF RECOVERY AGAINST OTHERS TO US

This endorsement modifies insurance provided under the following:

COMMERCIAL GENERAL LIABILITY COVERAGE PART  
PRODUCTS/COMPLETED OPERATIONS LIABILITY COVERAGE PART

### SCHEDULE

**Name of person or organization:**

**Any person or organization you have agreed in writing to  
waive any right of recovery prior to a loss**

Information required to complete this Schedule, if not shown above, will be shown in the Declarations.

The following is added to Paragraph 8. **Transfer Of Rights Of Recovery Against Others To Us** of Section IV – Conditions:

We waive any right of recovery we may have against the person or organization shown in the Schedule above because of payments we make for injury or damage arising out of your ongoing operations or "your work" done under a contract with that person or organization and included in the "products-completed operations hazard". This waiver applies only to the person or organization shown in the Schedule above.

**THIS ENDORSEMENT CHANGES THE POLICY. PLEASE READ IT CAREFULLY.**

## **DESIGNATED INSURED FOR COVERED AUTOS LIABILITY COVERAGE**

This endorsement modifies insurance provided under the following:

AUTO DEALERS COVERAGE FORM  
BUSINESS AUTO COVERAGE FORM  
MOTOR CARRIER COVERAGE FORM

With respect to coverage provided by this endorsement, the provisions of the Coverage Form apply unless modified by this endorsement.

This endorsement identifies person(s) or organization(s) who are "insureds" for Covered Autos Liability Coverage under the Who Is An Insured provision of the Coverage Form. This endorsement does not alter coverage provided in the Coverage Form.

### **SCHEDULE**

**Name Of Person(s) Or Organization(s):**

Any person or organization that the Named Insured has agreed and/or is obligated by contract or agreement to name as an Additional Insured, provided that the coverage afforded to the Additional Insured shall apply only to the extent of such contract or agreement and shall be subject to all the terms, conditions, exclusions and endorsements of this policy

Information required to complete this Schedule, if not shown above, will be shown in the Declarations.

Each person or organization shown in the Schedule is an "insured" for Covered Autos Liability Coverage, but only to the extent that person or organization qualifies as an "insured" under the Who Is An Insured provision contained in Paragraph A.1. of Section II – Covered Autos Liability Coverage in the Business Auto and Motor Carrier Coverage Forms and Paragraph D.2. of Section I – Covered Autos Coverages of the Auto Dealers Coverage Form.

Policy Number: AS2-631-510814-012  
Issued by: Liberty Mutual Fire Insurance Co

**THIS ENDORSEMENT CHANGES THE POLICY. PLEASE READ IT CAREFULLY.**

**DESIGNATED INSURED - NONCONTRIBUTING**

This endorsement modifies insurance provided under the following:

BUSINESS AUTO COVERAGE FORM  
GARAGE COVERAGE FORM  
MOTOR CARRIERS COVERGE FORM  
TRUCKERS COVERAGE FORM

With respect to coverage provided by this endorsement, the provisions of the Coverage Form apply unless modified by this endorsement.

This endorsement identifies person(s) or organization(s) who are "insureds" under the Who Is An Insured Provision of the Coverage Form. This endorsement does not alter coverage provided in the Coverage form.

**Schedule**

**Name of Person(s) or Organizations(s):** Where required by written contract entered prior to a loss

**Regarding Designated Contract or Project:** All locations as required by a written contract or agreement

Each person or organization shown in the Schedule of this endorsement is an "insured" for Liability Coverage, but only to the extent that person or organization qualifies as an "insured" under the Who Is An Insured Provision contained in Section II of the Coverage Form.

The following is added to the **Other Insurance Condition:**

If you have agreed in a written agreement that this policy will be primary and without right of contribution from any insurance in force for an Additional Insured for liability arising out of your operations, and the agreement was executed prior to the "bodily injury" or "property damage", then this insurance will be primary and we will not seek contribution from such insurance.

**THIS ENDORSEMENT CHANGES THE POLICY. PLEASE READ IT CAREFULLY.**

**WAIVER OF TRANSFER OF RIGHTS OF RECOVERY  
AGAINST OTHERS TO US (WAIVER OF SUBROGATION)**

This endorsement modifies insurance provided under the following:

AUTO DEALERS COVERAGE FORM  
BUSINESS AUTO COVERAGE FORM  
MOTOR CARRIER COVERAGE FORM

With respect to coverage provided by this endorsement, the provisions of the Coverage Form apply unless modified by the endorsement.

**SCHEDULE**

**Name(s) Of Person(s) Or Organization(s):**

Any person or organization you have agreed in writing to waive any right of recovery prior to a loss

Information required to complete this Schedule, if not shown above, will be shown in the Declarations.

**The Transfer Of Rights Of Recovery Against Others To Us** condition does not apply to the person(s) or organization(s) shown in the Schedule, but only to the extent that subrogation is waived prior to the "accident" or the "loss" under a contract with that person or organization.



## WAIVER OF OUR RIGHT TO RECOVER FROM OTHERS ENDORSEMENT

We have the right to recover our payments from anyone liable for an injury covered by this policy. We will not enforce our right against the person or organization named in the Schedule. (This agreement applies only to the extent that you perform work under a written contract that requires you to obtain this agreement from us.)

This agreement shall not operate directly or indirectly to benefit anyone not named in the Schedule.

### Schedule

Any person or organization you have agreed in writing to waive any right of recovery prior to a loss

Issued by: Liberty Mutual Fire Insurance Co 23035

For attachment to Policy No WA2-63D-510814-032

Effective Date 07/01/2022 Premium \$ Included

Issued to: Ferreira Construction Co. Inc.



# CERTIFICATE OF LIABILITY INSURANCE

DATE (MM/DD/YYYY)

9/12/2022

THIS CERTIFICATE IS ISSUED AS A MATTER OF INFORMATION ONLY AND CONFERS NO RIGHTS UPON THE CERTIFICATE HOLDER. THIS CERTIFICATE DOES NOT AFFIRMATIVELY OR NEGATIVELY AMEND, EXTEND OR ALTER THE COVERAGE AFFORDED BY THE POLICIES BELOW. THIS CERTIFICATE OF INSURANCE DOES NOT CONSTITUTE A CONTRACT BETWEEN THE ISSUING INSURER(S), AUTHORIZED REPRESENTATIVE OR PRODUCER, AND THE CERTIFICATE HOLDER.

IMPORTANT: If the certificate holder is an ADDITIONAL INSURED, the policy(ies) must have ADDITIONAL INSURED provisions or be endorsed. If SUBROGATION IS WAIVED, subject to the terms and conditions of the policy, certain policies may require an endorsement. A statement on this certificate does not confer any rights to the certificate holder in lieu of such endorsement(s).

<b>PRODUCER</b> <b>Conner Strong &amp; Buckelew</b> <b>32 Old Slip, Suite 32B</b> <b>New York, NY 10005</b>	<b>CONTACT NAME:</b> <b>Gianna Costello</b>
	<b>PHONE (A/C, No, Ext):</b> <b>646-891-4983</b> <b>FAX (A/C, No):</b> <b>646-862-8242</b> <b>E-MAIL ADDRESS:</b> <b>gcostello@connerstrong.com</b>
<b>INSURED</b>  <b>Ferreira Construction Co. Inc. dba</b> <b>Ferreira Coastal Construction Co.</b> <b>10370 Commerce Center Drive, Suite B-200</b> <b>Rancho Cucamonga, CA 91730</b>	<b>INSURER(S) AFFORDING COVERAGE</b> <b>NAIC #</b>
	<b>INSURER A :</b> Liberty Mutual Fire Insurance Co. <b>23035</b>
	<b>INSURER B :</b> Endurance American Specialty Ins. Co. <b>41718</b>
	<b>INSURER C :</b> Westfield Specialty Insurance Company <b>16992</b>
	<b>INSURER D :</b> Arch Specialty Insurance Company <b>21199</b>
	<b>INSURER E :</b> <b>INSURER F :</b>

**COVERAGES**      **CERTIFICATE NUMBER:**      **REVISION NUMBER:**

THIS IS TO CERTIFY THAT THE POLICIES OF INSURANCE LISTED BELOW HAVE BEEN ISSUED TO THE INSURED NAMED ABOVE FOR THE POLICY PERIOD INDICATED. NOTWITHSTANDING ANY REQUIREMENT, TERM OR CONDITION OF ANY CONTRACT OR OTHER DOCUMENT WITH RESPECT TO WHICH THIS CERTIFICATE MAY BE ISSUED OR MAY PERTAIN, THE INSURANCE AFFORDED BY THE POLICIES DESCRIBED HEREIN IS SUBJECT TO ALL THE TERMS, EXCLUSIONS AND CONDITIONS OF SUCH POLICIES. LIMITS SHOWN MAY HAVE BEEN REDUCED BY PAID CLAIMS.

INSR LTR	TYPE OF INSURANCE	ADDL SUBR INSR WVD	POLICY NUMBER	POLICY EFF (MM/DD/YYYY)	POLICY EXP (MM/DD/YYYY)	LIMITS
A	<input checked="" type="checkbox"/> COMMERCIAL GENERAL LIABILITY <input type="checkbox"/> CLAIMS-MADE <input checked="" type="checkbox"/> OCCUR  GEN'L AGGREGATE LIMIT APPLIES PER: <input type="checkbox"/> POLICY <input checked="" type="checkbox"/> PRO-JECT <input checked="" type="checkbox"/> LOC OTHER:		TB2631510814022	07/01/2022	07/01/2023	EACH OCCURRENCE \$2,000,000 DAMAGE TO RENTED PREMISES (Ea occurrence) \$1,000,000 MED EXP (Any one person) \$10,000 PERSONAL & ADV INJURY \$2,000,000 GENERAL AGGREGATE \$4,000,000 PRODUCTS - COMP/OP AGG \$4,000,000 \$
A	AUTOMOBILE LIABILITY <input checked="" type="checkbox"/> ANY AUTO OWNED AUTOS ONLY <input type="checkbox"/> SCHEDULED AUTOS <input checked="" type="checkbox"/> HIRED AUTOS ONLY <input checked="" type="checkbox"/> NON-OWNED AUTOS ONLY		AS2631510814012	07/01/2022	07/01/2023	COMBINED SINGLE LIMIT (Ea accident) \$2,000,000 BODILY INJURY (Per person) \$ BODILY INJURY (Per accident) \$ PROPERTY DAMAGE (Per accident) \$ \$
B	<input type="checkbox"/> UMBRELLA LIAB <input checked="" type="checkbox"/> OCCUR <input checked="" type="checkbox"/> EXCESS LIAB <input type="checkbox"/> CLAIMS-MADE DED    RETENTION \$		EXC30000705504	07/01/2022	07/01/2023	EACH OCCURRENCE \$3,000,000 AGGREGATE \$3,000,000 \$
A	WORKERS COMPENSATION AND EMPLOYERS' LIABILITY ANY PROPRIETOR/PARTNER/EXECUTIVE OFFICER/MEMBER EXCLUDED? (Mandatory in NH) If yes, describe under DESCRIPTION OF OPERATIONS below	Y/N <input checked="" type="checkbox"/> N    N/A	WA263D510814032	07/01/2022	07/01/2023	<input checked="" type="checkbox"/> PER STATUTE <input type="checkbox"/> OTH-ER E.L. EACH ACCIDENT \$1,000,000 E.L. DISEASE - EA EMPLOYEE \$1,000,000 E.L. DISEASE - POLICY LIMIT \$1,000,000
C	Excess Liability		XSL00014GY	07/01/2022	07/01/2023	\$2M Occ. / \$2M Agg
D	Excess Liability		UXP104938200	07/01/2022	07/01/2023	\$3M Occ. / \$3M Agg

DESCRIPTION OF OPERATIONS / LOCATIONS / VEHICLES (ACORD 101, Additional Remarks Schedule, may be attached if more space is required)

**Coverage: Excess Liability (4th Layer - \$5M x \$8M)**  
**Carrier: Colony Insurance Company (NAIC#: 39993)**  
**Policy Term: 07/01/2022 to 07/01/2023**  
**Policy #: AR6461134**  
**Limits: \$2,500,000 Per Occurrence / Aggregate (part of \$5,000,000 Quota Share with Evanston Insurance)**  
**(See Attached Descriptions)**

<b>CERTIFICATE HOLDER</b>  <b>City of San Clemente</b> <b>Attn. Amir Ilkhanipour</b> <b>900 Calle Negocio</b> <b>San Clemente, CA 92673</b>	<b>CANCELLATION</b>  <b>SHOULD ANY OF THE ABOVE DESCRIBED POLICIES BE CANCELLED BEFORE THE EXPIRATION DATE THEREOF, NOTICE WILL BE DELIVERED IN ACCORDANCE WITH THE POLICY PROVISIONS.</b>  <b>AUTHORIZED REPRESENTATIVE</b>  <i>W. Michael Triguero</i>
--	--

## DESCRIPTIONS (Continued from Page 1)

Company)

Coverage: Excess Liability (4th Layer - \$5M x \$8M)

Carrier: Evanston Insurance Company (NAIC#: 35378)

Policy Term: 07/01/2022 to 07/01/2023

Policy #: MKLV7EUE100768

Limits: \$2,500,000 Per Occurrence / Aggregate (part of \$5,000,000 Quota Share with Colony Insurance Company)

Coverage: Excess Liability (5th Layer - \$12M x \$13M)

Carrier: Navigators Insurance Company (NAIC#: 42307)

Policy Term: 07/01/2022 to 07/01/2023

Policy #: NY22EXCZ02BJWIV

Limits: \$12,000,000 Per Occurrence / Aggregate

RE: FCC Job #5391, 216 La Cuesta Sewer Repair and Manhole Construction

Location: 216 Avenida La Cuesta, San Clemente

The City, its officials, officers, employees, agents, and volunteers are Additional Insureds on the above referenced General Liability and Automobile Liability Policies, but only to the extent if required by written contract and provided in the Additional Insured Endorsement attached to the policy, a copy of which is available upon request.

General Liability and Automobile Liability Policies will pay for covered loss on a primary basis and the Insurance Company will not seek contribution from the Certificate Holder for such loss until the Insurance Carriers primary limits of liability have been exhausted.

Where permitted by state law, the Insurer waives its right to subrogate against the Certificate Holder by reason of payments made under General Liability, Automobile Liability, and Workers Compensation Policies, but only under the circumstances stated in the policy.

**THIS ENDORSEMENT CHANGES THE POLICY. PLEASE READ IT CAREFULLY.**

**ADDITIONAL INSURED – OWNERS, LESSEES OR CONTRACTORS – COMPLETED OPERATIONS**

This endorsement modifies insurance provided under the following:

COMMERCIAL GENERAL LIABILITY COVERAGE PART  
PRODUCTS/COMPLETED OPERATIONS LIABILITY COVERAGE PART

**SCHEDULE**

Name Of Additional Insured Person(s) Or Organization(s)	Location And Description Of Completed Operations
All persons or organizations as required by written contract or agreement, prior to an "occurrence" or offence, to provide additional insured status	Per the contract or agreement
Information required to complete this Schedule, if not shown above, will be shown in the Declarations.	

**A. Section II – Who Is An Insured** is amended to include as an additional insured the person(s) or organization(s) shown in the Schedule, but only with respect to liability for "bodily injury" or "property damage" caused, in whole or in part, by "your work" at the location designated and described in the Schedule of this endorsement performed for that additional insured and included in the "products-completed operations hazard".

However:

1. The insurance afforded to such additional insured only applies to the extent permitted by law; and
2. If coverage provided to the additional insured is required by a contract or agreement, the insurance afforded to such additional insured will not be broader than that which you are required by the contract or agreement to provide for such additional insured.

**B.** With respect to the insurance afforded to these additional insureds, the following is added to **Section III – Limits Of Insurance:**

If coverage provided to the additional insured is required by a contract or agreement, the most we will pay on behalf of the additional insured is the amount of insurance:

1. Required by the contract or agreement; or
2. Available under the applicable limits of insurance;

whichever is less.

This endorsement shall not increase the applicable limits of insurance.

**THIS ENDORSEMENT CHANGES THE POLICY. PLEASE READ IT CAREFULLY.**

**ADDITIONAL INSURED – OWNERS, LESSEES OR CONTRACTORS – SCHEDULED PERSON OR ORGANIZATION**

This endorsement modifies insurance provided under the following:

COMMERCIAL GENERAL LIABILITY COVERAGE PART

**SCHEDULE**

Name Of Additional Insured Person(s) Or Organization(s)	Location(s) Of Covered Operations
All persons or organizations as required by written contract or agreement, prior to an "occurrence" or offence, to provide additional insured status	Per the contract or agreement
Information required to complete this Schedule, if not shown above, will be shown in the Declarations.	

**A. Section II – Who Is An Insured** is amended to include as an additional insured the person(s) or organization(s) shown in the Schedule, but only with respect to liability for "bodily injury", "property damage" or "personal and advertising injury" caused, in whole or in part, by:

1. Your acts or omissions; or
2. The acts or omissions of those acting on your behalf;

in the performance of your ongoing operations for the additional insured(s) at the location(s) designated above.

However:

1. The insurance afforded to such additional insured only applies to the extent permitted by law; and
2. If coverage provided to the additional insured is required by a contract or agreement, the insurance afforded to such additional insured will not be broader than that which you are required by the contract or agreement to provide for such additional insured.

**B.** With respect to the insurance afforded to these additional insureds, the following additional exclusions apply:

This insurance does not apply to "bodily injury" or "property damage" occurring after:

1. All work, including materials, parts or equipment furnished in connection with such work, on the project (other than service, maintenance or repairs) to be performed by or on behalf of the additional insured(s) at the location of the covered operations has been completed; or
2. That portion of "your work" out of which the injury or damage arises has been put to its intended use by any person or organization other than another contractor or subcontractor engaged in performing operations for a principal as a part of the same project.

C. With respect to the insurance afforded to these additional insureds, the following is added to **Section III – Limits Of Insurance:**

If coverage provided to the additional insured is required by a contract or agreement, the most we will pay on behalf of the additional insured is the amount of insurance:

1. Required by the contract or agreement; or

2. Available under the applicable limits of insurance;

whichever is less.

This endorsement shall not increase the applicable limits of insurance.

Policy Number TB2-631-510814-022  
Issued by Liberty Mutual Fire Insurance Co

**THIS ENDORSEMENT CHANGES THE POLICY. PLEASE READ IT CAREFULLY.**

**OTHER INSURANCE AMENDMENT – SCHEDULED ADDITIONAL INSURED**

This endorsement modifies insurance provided under the following:

COMMERCIAL GENERAL LIABILITY COVERAGE PART  
PRODUCTS/COMPLETED OPERATIONS LIABILITY COVERAGE PART  
LIQUOR LIABILITY COVERAGE PART

**Schedule**

**Name of Person(s) or Organization(s):** Any person(s) or Organization(s) to whom you are Obligated by a written agreement to procure additional insured coverage under your policy

If you are obligated under a written agreement to provide liability insurance on a primary, excess, contingent, or any other basis for any person(s) or organization(s) shown in the Schedule of this endorsement that qualifies as an additional insured on this Policy, this Policy will apply solely on the basis required by such written agreement and Paragraph 4. **Other Insurance of Section IV – Conditions** will not apply. Where the applicable written agreement does not specify on what basis the liability insurance will apply, the provisions of Paragraph 4. **Other Insurance of Section IV – Conditions** will apply. However, this insurance is excess over any other insurance available to the additional insured for which it is also covered as an additional insured for the same "occurrence", claim or "suit".



## WAIVER OF TRANSFER OF RIGHTS OF RECOVERY AGAINST OTHERS TO US

This endorsement modifies insurance provided under the following:

COMMERCIAL GENERAL LIABILITY COVERAGE PART  
PRODUCTS/COMPLETED OPERATIONS LIABILITY COVERAGE PART

### SCHEDULE

<p><b>Name of person or organization:</b> <b>Any person or organization you have agreed in writing to waive any right of recovery prior to a loss</b></p>
<p>Information required to complete this Schedule, if not shown above, will be shown in the Declarations.</p>

The following is added to Paragraph **8. Transfer Of Rights Of Recovery Against Others To Us** of **Section IV – Conditions:**

We waive any right of recovery we may have against the person or organization shown in the Schedule above because of payments we make for injury or damage arising out of your ongoing operations or "your work" done under a contract with that person or organization and included in the "products-completed operations hazard". This waiver applies only to the person or organization shown in the Schedule above.

**THIS ENDORSEMENT CHANGES THE POLICY. PLEASE READ IT CAREFULLY.**

## **DESIGNATED INSURED FOR COVERED AUTOS LIABILITY COVERAGE**

This endorsement modifies insurance provided under the following:

AUTO DEALERS COVERAGE FORM  
BUSINESS AUTO COVERAGE FORM  
MOTOR CARRIER COVERAGE FORM

With respect to coverage provided by this endorsement, the provisions of the Coverage Form apply unless modified by this endorsement.

This endorsement identifies person(s) or organization(s) who are "insureds" for Covered Autos Liability Coverage under the Who Is An Insured provision of the Coverage Form. This endorsement does not alter coverage provided in the Coverage Form.

### **SCHEDULE**

**Name Of Person(s) Or Organization(s):**

Any person or organization that the Named Insured has agreed and/or is obligated by contract or agreement to name as an Additional Insured, provided that the coverage afforded to the Additional Insured shall apply only to the extent of such contract or agreement and shall be subject to all the terms, conditions, exclusions and endorsements of this policy

Information required to complete this Schedule, if not shown above, will be shown in the Declarations.

Each person or organization shown in the Schedule is an "insured" for Covered Autos Liability Coverage, but only to the extent that person or organization qualifies as an "insured" under the Who Is An Insured provision contained in Paragraph **A.1.** of Section **II** – Covered Autos Liability Coverage in the Business Auto and Motor Carrier Coverage Forms and Paragraph **D.2.** of Section **I** – Covered Autos Coverages of the Auto Dealers Coverage Form.

Policy Number: AS2-631-510814-012  
Issued by: Liberty Mutual Fire Insurance Co

**THIS ENDORSEMENT CHANGES THE POLICY. PLEASE READ IT CAREFULLY.**

**DESIGNATED INSURED - NONCONTRIBUTING**

This endorsement modifies insurance provided under the following:

BUSINESS AUTO COVERAGE FORM  
GARAGE COVERAGE FORM  
MOTOR CARRIERS COVERGE FORM  
TRUCKERS COVERAGE FORM

With respect to coverage provided by this endorsement, the provisions of the Coverage Form apply unless modified by this endorsement.

This endorsement identifies person(s) or organization(s) who are "insureds" under the Who Is An Insured Provision of the Coverage Form. This endorsement does not alter coverage provided in the Coverage form.

**Schedule**

**Name of Person(s) or Organizations(s):** Where required by written contract entered prior to a loss

**Regarding Designated Contract or Project:** All locations as required by a written contract or agreement

Each person or organization shown in the Schedule of this endorsement is an "insured" for Liability Coverage, but only to the extent that person or organization qualifies as an "insured" under the Who Is An Insured Provision contained in Section II of the Coverage Form.

The following is added to the **Other Insurance Condition:**

If you have agreed in a written agreement that this policy will be primary and without right of contribution from any insurance in force for an Additional Insured for liability arising out of your operations, and the agreement was executed prior to the "bodily injury" or "property damage", then this insurance will be primary and we will not seek contribution from such insurance.

**THIS ENDORSEMENT CHANGES THE POLICY. PLEASE READ IT CAREFULLY.**

**WAIVER OF TRANSFER OF RIGHTS OF RECOVERY  
AGAINST OTHERS TO US (WAIVER OF SUBROGATION)**

This endorsement modifies insurance provided under the following:

AUTO DEALERS COVERAGE FORM  
BUSINESS AUTO COVERAGE FORM  
MOTOR CARRIER COVERAGE FORM

With respect to coverage provided by this endorsement, the provisions of the Coverage Form apply unless modified by the endorsement.

**SCHEDULE**

**Name(s) Of Person(s) Or Organization(s):**

Any person or organization you have agreed in writing to waive any right of recovery prior to a loss

Information required to complete this Schedule, if not shown above, will be shown in the Declarations.

The **Transfer Of Rights Of Recovery Against Others To Us** condition does not apply to the person(s) or organization(s) shown in the Schedule, but only to the extent that subrogation is waived prior to the "accident" or the "loss" under a contract with that person or organization.

## WAIVER OF OUR RIGHT TO RECOVER FROM OTHERS ENDORSEMENT

We have the right to recover our payments from anyone liable for an injury covered by this policy. We will not enforce our right against the person or organization named in the Schedule. (This agreement applies only to the extent that you perform work under a written contract that requires you to obtain this agreement from us.)

This agreement shall not operate directly or indirectly to benefit anyone not named in the Schedule.

### Schedule

Any person or organization you have agreed in writing to waive any right of recovery prior to a loss

Issued by: Liberty Mutual Fire Insurance Co 23035

For attachment to Policy No WA2-63D-510814-032

Effective Date 07/01/2022 Premium \$ Included

Issued to: Ferreira Construction Co. Inc.