

CITY OF SAN CLEMENTE
CONSTRUCTION CONTRACT

CAPISTRANO LANE SANITARY SEWER LINE REPAIR, PN 24200

1. PARTIES AND DATE.

This Contract is made and entered into this 15 day of February, 2022 by and between the City of San Clemente, a public agency of the State of California ("City") and O'Connell Engineering & Construction, Inc., ("Contractor"). City and Contractor are sometimes individually referred to as "Party" and collectively as "Parties" in this Contract.

2. RECITALS.

2.1 City. City is a public agency organized under the laws of the State of California, with power to contract for services necessary to achieve its purpose.

2.2 Contractor. Contractor desires to perform and assume responsibility for the provision of certain construction services required by the City on the terms and conditions set forth in this Contract. Contractor represents that it is duly licensed and experienced in providing CAPISTRANO LANE SANITARY SEWER LINE REPAIR, PN 24200 related construction services to public clients, that it and its employees or subcontractors have all necessary licenses and permits to perform the services in the State of California, and that it is familiar with the plans of City. The following license classifications are required for this Project: California Contract License Class A.

2.3 Project. City desires to engage Contractor to render such services for the CAPISTRANO LANE SANITARY SEWER LINE REPAIR ("Project") as set forth in this Contract.

2.4 Project Documents & Certifications. Contractor has obtained, and delivers concurrently herewith, a performance bond, a payment bond, and all insurance documentation, as required by the Contract.

3. TERMS

3.1 Incorporation of Documents. This Contract includes and hereby incorporates in full by reference the following documents, including all exhibits, drawings, specifications and documents therein, and attachments and addenda thereto:

- Services/Schedule (Exhibit "A")
- Plans and Specifications (Exhibit "B")
- Special Conditions (Exhibit "C")
- Contractor's Certificate Regarding Workers' Compensation (Exhibit "D")
- Public Works Contractor Registration Certification (Exhibit "E")
- Payment and Performance Bonds (Exhibit "F")
- Federal Requirements (Exhibit "G") (Not Applicable)
- Insurance Requirements (Exhibit "H")
- Addenda
- Change Orders executed by the City

- 2021 Edition of the Standard Specifications for Public Works Construction (The Greenbook), Excluding Sections 1-8
- Notice Inviting Bids, if any
- Instructions to Bidders, if any
- Contractor's Bid

3.2 Contractor's Basic Obligation; Scope of Work. Contractor promises and agrees, at its own cost and expense, to furnish to the City all labor, materials, tools, equipment, services, and incidental and customary work necessary to fully and adequately complete the Project, including all structures and facilities necessary for the Project or described in the Contract (hereinafter sometimes referred to as the "Work"), for a Total Contract Price as specified pursuant to this Contract. All Work shall be subject to, and performed in accordance with the above referenced documents, as well as the exhibits attached hereto and incorporated herein by reference. The plans and specifications for the Work are further described in Exhibit "B" attached hereto and incorporated herein by this reference. Special Conditions, if any, relating to the Work are described in Exhibit "C" attached hereto and incorporated herein by this reference.

3.2.1 Change in Scope of Work. Any change in the scope of the Work, method of performance, nature of materials or price thereof, or any other matter materially affecting the performance or nature of the Work shall not be paid for or accepted unless such change, addition or deletion is approved in writing by a valid change order executed by the City. Should Contractor request a change order due to unforeseen circumstances affecting the performance of the Work, such request shall be made within five (5) business days of the date such circumstances are discovered or shall waive its right to request a change order due to such circumstances. If the Parties cannot agree on any change in price required by such change in the Work, the City may direct the Contractor to proceed with the performance of the change on a time and materials basis.

3.2.2 Substitutions/"Or Equal". Pursuant to Public Contract Code Section 3400(b), the City may make a finding that designates certain products, things, or services by specific brand or trade name. Unless specifically designated in this Contract, whenever any material, process, or article is indicated or specified by grade, patent, or proprietary name or by name of manufacturer, such Specifications shall be deemed to be used for the purpose of facilitating the description of the material, process or article desired and shall be deemed to be followed by the words "or equal."

Contractor may, unless otherwise stated, offer for substitution any material, process or article which shall be substantially equal or better in every respect to that so indicated or specified in this Contract. However, the City may have adopted certain uniform standards for certain materials, processes and articles. Contractor shall submit requests, together with substantiating data, for substitution of any "or equal" material, process or article no later than thirty-five (35) days after award of the Contract. To facilitate the construction schedule and sequencing, some requests may need to be submitted before thirty-five (35) days after award of Contract. Provisions regarding submission of "or equal" requests shall not in any way authorize an extension of time for performance of this Contract. If a proposed "or equal" substitution request is rejected, Contractor shall be responsible for providing the specified material, process or article. The burden of proof as to the equality of any material, process or article shall rest with Contractor.

The City has the complete and sole discretion to determine if a material, process or article is an "or equal" material, process or article that may be substituted. Data required to substantiate requests for substitutions of an "or equal" material, process or article data shall

include a signed affidavit from Contractor stating that, and describing how, the substituted "or equal" material, process or article is equivalent to that specified in every way except as listed on the affidavit. Substantiating data shall include any and all illustrations, specifications, and other relevant data including catalog information which describes the requested substituted "or equal" material, process or article, and substantiates that it is an "or equal" to the material, process or article. The substantiating data must also include information regarding the durability and lifecycle cost of the requested substituted "or equal" material, process or article. Failure to submit all the required substantiating data, including the signed affidavit, to the City in a timely fashion will result in the rejection of the proposed substitution.

Contractor shall bear all of the City's costs associated with the review of substitution requests. Contractor shall be responsible for all costs related to a substituted "or equal" material, process or article. Contractor is directed to the Special Conditions (if any) to review any findings made pursuant to Public Contract Code section 3400.

3.3 Period of Performance.

3.3.1 Contract Time. Contractor shall perform and complete all Work under this Contract within Thirty (30) working days, beginning the effective date of the Notice to Proceed ("Contract Time"). Contractor shall perform its Work in strict accordance with any completion schedule, construction schedule or project milestones developed by the City. Such schedules or milestones may be included as part of Exhibits "A" or "B" attached hereto, or may be provided separately in writing to Contractor. Contractor agrees that if such Work is not completed within the aforementioned Contract Time and/or pursuant to any such completion schedule, construction schedule or project milestones developed pursuant to provisions of the Contract, it is understood, acknowledged and agreed that the City will suffer damage.

3.3.2 Force Majeure. Neither City nor Contractor shall be considered in default of this Contract for delays in performance caused by circumstances beyond the reasonable control of the non-performing party. For purposes of this Contract, such circumstances include but are not limited to, abnormal weather conditions; floods; earthquakes; fire; pandemics or epidemics; war; riots and other civil disturbances; strikes, lockouts, work slowdowns, and other labor disturbances; sabotage or judicial restraint. Should such circumstances occur, the non-performing party shall, within a reasonable time of being prevented from performing, give written notice to the other party describing the circumstances preventing continued performance and the efforts being made to resume performance of this Contract. Contractor's exclusive remedy in the event of delay covered under this section shall be a non-compensable extension of the Contract Time.

3.3.3 Liquidated Damages. Pursuant to Government Code Section 53069.85, Contractor shall pay to the City as fixed and liquidated damages the sum of One Thousand Dollars (\$1,000) per day for each and every calendar day of delay beyond the Contract Time or beyond any completion schedule, construction schedule or Project milestones established pursuant to the Contract.

3.4 Standard of Performance; Performance of Employees. Contractor shall perform all Work under this Contract in a skillful and workmanlike manner, and consistent with the standards generally recognized as being employed by professionals in the same discipline in the State of California. Contractor represents and maintains that it is skilled in the professional calling necessary to perform the Work. Contractor warrants that all employees and subcontractors shall have sufficient skill and experience to perform the Work assigned to them. Finally, Contractor

represents that it, its employees and subcontractors have all licenses, permits, qualifications and approvals of whatever nature that are legally required to perform the Work, including any required business license, and that such licenses and approvals shall be maintained throughout the term of this Contract. As provided for in the indemnification provisions of this Contract, Contractor shall perform, at its own cost and expense and without reimbursement from the City, any work necessary to correct errors or omissions which are caused by Contractor's failure to comply with the standard of care provided for herein. Any employee who is determined by the City to be uncooperative, incompetent, a threat to the safety of persons or the Work, or any employee who fails or refuses to perform the Work in a manner acceptable to the City, shall be promptly removed from the Project by Contractor and shall not be re-employed on the Work.

3.5 Control and Payment of Subordinates: Contractual Relationship. City retains Contractor on an independent contractor basis and Contractor is not an employee of City. Any additional personnel performing the work governed by this Contract on behalf of Contractor shall at all times be under Contractor's exclusive direction and control. Contractor shall pay all wages, salaries, and other amounts due such personnel in connection with their performance under this Contract and as required by law. Contractor shall be responsible for all reports and obligations respecting such additional personnel, including, but not limited to: social security taxes, income tax withholding, unemployment insurance, and workers' compensation insurance.

3.6 City's Basic Obligation. City agrees to engage and does hereby engage Contractor as an independent contractor to furnish all materials and to perform all Work according to the terms and conditions herein contained for the sum set forth above. Except as otherwise provided in the Contract, the City shall pay to Contractor, as full consideration for the satisfactory performance by Contractor of the services and obligations required by this Contract, the below-referenced compensation in accordance with compensation provisions set forth in the Contract.

3.7 Compensation and Payment.

3.7.1 Amount of Compensation. As consideration for performance of the Work required herein, City agrees to pay Contractor the Total Contract Price of Forty Six Thousand Seven Hundred Dollars (\$46,700.00) ("Total Contract Price") provided that such amount shall be subject to adjustment pursuant to the applicable terms of this Contract or written change orders approved and signed in advance by the City.

3.7.2 Payment of Compensation. If the Work is scheduled for completion in Thirty (30) or less calendar days, City will arrange for payment of the Total Contract Price upon completion and approval by City of the Work. If the Work is scheduled for completion in more than thirty (30) calendar days, City will pay Contractor on a monthly basis as provided for herein. On or before the fifth (5th) day of each month, Contractor shall submit to the City an itemized application for payment in the format supplied by the City indicating the amount of Work completed since commencement of the Work or since the last progress payment. These applications shall be supported by evidence which is required by this Contract and such other documentation as the City may require. The Contractor shall certify that the Work for which payment is requested has been done and that the materials listed are stored where indicated. Contractor may be required to furnish a detailed schedule of values upon request of the City and in such detail and form as the City shall request, showing the quantities, unit prices, overhead, profit, and all other expenses involved in order to provide a basis for determining the amount of progress payments.

3.7.3 Prompt Payment. City shall review and pay all progress payment requests in accordance with the provisions set forth in Section 20104.50 of the California Public Contract

Code. However, no progress payments will be made for Work not completed in accordance with this Contract. Contractor shall comply with all applicable laws, rules and regulations relating to the proper payment of its employees, subcontractors, suppliers or others.

3.7.4 Contract Retentions. From each approved progress estimate, five percent (5%) will be deducted and retained by the City, and the remainder will be paid to Contractor. All Contract retention shall be released and paid to Contractor and subcontractors pursuant to California Public Contract Code Section 7107.

3.7.5 Other Retentions. In addition to Contract retentions, the City may deduct from each progress payment an amount necessary to protect City from loss because of: (1) liquidated damages which have accrued as of the date of the application for payment; (2) any sums expended by the City in performing any of Contractor's obligations under the Contract which Contractor has failed to perform or has performed inadequately; (3) defective Work not remedied; (4) stop notices as allowed by state law; (5) reasonable doubt that the Work can be completed for the unpaid balance of the Total Contract Price or within the scheduled completion date; (6) unsatisfactory prosecution of the Work by Contractor; (7) unauthorized deviations from the Contract; (8) failure of Contractor to maintain or submit on a timely basis proper and sufficient documentation as required by the Contract or by City during the prosecution of the Work; (9) erroneous or false estimates by Contractor of the value of the Work performed; (10) any sums representing expenses, losses, or damages as determined by the City, incurred by the City for which Contractor is liable under the Contract; and (11) any other sums which the City is entitled to recover from Contractor under the terms of the Contract or pursuant to state law, including Section 1727 of the California Labor Code. The failure by the City to deduct any of these sums from a progress payment shall not constitute a waiver of the City's right to such sums.

3.7.6 Substitutions for Contract Retentions. In accordance with California Public Contract Code Section 22300, the City will permit the substitution of securities for any monies withheld by the City to ensure performance under the Contract. At the request and expense of Contractor, securities equivalent to the amount withheld shall be deposited with the City, or with a state or federally chartered bank in California as the escrow agent, and thereafter the City shall then pay such monies to Contractor as they come due. Upon satisfactory completion of the Contract, the securities shall be returned to Contractor. For purposes of this Section and Section 22300 of the Public Contract Code, the term "satisfactory completion of the contract" shall mean the time the City has issued written final acceptance of the Work and filed a Notice of Completion as required by law and provisions of this Contract. Contractor shall be the beneficial owner of any securities substituted for monies withheld and shall receive any interest thereon. The escrow agreement used for the purposes of this Section shall be in the form provided by the City.

3.7.7 Title to Work. As security for partial, progress, or other payments, title to Work for which such payments are made shall pass to the City at the time of payment. To the extent that title has not previously been vested in the City by reason of payments, full title shall pass to the City at delivery of the Work at the destination and time specified in this Contract. Such transferred title shall in each case be good, free and clear from any and all security interests, liens, or other encumbrances. Contractor promises and agrees that it will not pledge, hypothecate, or otherwise encumber the items in any manner that would result in any lien, security interest, charge, or claim upon or against said items. Such transfer of title shall not imply acceptance by the City, nor relieve Contractor from the responsibility to strictly comply with the Contract, and shall not relieve Contractor of responsibility for any loss of or damage to items.

3.7.8 Labor and Material Releases. Contractor shall furnish City with labor and material releases from all subcontractors performing work on, or furnishing materials for, the Work governed by this Contract prior to final payment by City.

3.7.9 Prevailing Wages. Contractor is aware of the requirements of California Labor Code Section 1720 et seq., and 1770 et seq., as well as California Code of Regulations, Title 8, Section 16000 et seq., ("Prevailing Wage Laws"), which require the payment of prevailing wage rates and the performance of other requirements on "public works" and "maintenance" projects. Since the Services are being performed as part of an applicable "public works" or "maintenance" project, as defined by the Prevailing Wage Laws, and since the total compensation is \$1,000 or more, Contractor agrees to fully comply with such Prevailing Wage Laws. City shall provide Contractor with a copy of the prevailing rates of per diem wages in effect at the commencement of this Contract upon request. Contractor shall make copies of the prevailing rates of per diem wages for each craft, classification or type of worker needed to execute the Services available to interested parties upon request, and shall post copies at Contractor's principal place of business and at the project site. Contractor shall defend, indemnify and hold the City, its officials, officers, employees and agents free and harmless from any claim or liability arising out of any failure or alleged failure to comply with the Prevailing Wage Laws. Contractor and any subcontractor shall forfeit a penalty of up to \$200 per calendar day or portion thereof for each worker paid less than the prevailing wage rates.

3.7.10 Apprenticeable Crafts. When Contractor employs workmen in an apprenticeable craft or trade, Contractor shall comply with the provisions of Section 1777.5 of the California Labor Code with respect to the employment of properly registered apprentices upon public works. The primary responsibility for compliance with said section for all apprenticeable occupations shall be with Contractor. The Contractor or any subcontractor that is determined by the Labor Commissioner to have knowingly violated Section 1777.5 shall forfeit as a civil penalty an amount not exceeding \$100 for each full calendar day of noncompliance, or such greater amount as provided by law.

3.7.11 Hours of Work. Contractor is advised that eight (8) hours labor constitutes a legal day's work. Pursuant to Section 1813 of the California Labor Code, Contractor shall forfeit a penalty of \$25.00 per worker for each day that each worker is permitted to work more than eight (8) hours in any one calendar day and forty (40) hours in any one calendar week, except when payment for overtime is made at not less than one and one-half (1-1/2) times the basic rate for that worker.

3.7.12 Payroll Records. Contractor and each subcontractor shall keep an accurate payroll record, showing the name, address, social security number, work classification, straight time and overtime hours worked each day and week, and the actual per diem wages paid to each journeyman, apprentice, worker, or other employee employed by him or her in connection with the public work. The payroll records shall be certified and shall be available for inspection at all reasonable hours at the principal office of Contractor in the manner provided in Labor Code section 1776. In the event of noncompliance with the requirements of this section, Contractor shall have 10 days in which to comply subsequent to receipt of written notice specifying in what respects such Contractor must comply with this section. Should noncompliance still be evident after such 10-day period, Contractor shall, as a penalty to City, forfeit not more than \$100.00 for each calendar day or portion thereof, for each worker, until strict compliance is effectuated. The amount of the forfeiture is to be determined by the Labor Commissioner. A contractor who is found to have violated the provisions of law regarding wages on Public Works with the intent to defraud shall be ineligible to bid on Public Works contracts for a period of one to three years as

determined by the Labor Commissioner. Upon the request of the Division of Apprenticeship Standards or the Division of Labor Standards Enforcement, such penalties shall be withheld from progress payments then due. The responsibility for compliance with this section is on Contractor. The requirement to submit certified payroll records directly to the Labor Commissioner under Labor Code section 1771.4 shall not apply to work performed on a public works project that is exempt pursuant to the small project exemption specified in Labor Code Section 1771.4.

3.7.13 Contractor and Subcontractor Registration. Pursuant to Labor Code sections 1725.5 and 1771.1, all contractors and subcontractors that wish to bid on, be listed in a bid proposal, or enter into a contract to perform public work must be registered with the Department of Industrial Relations. No bid will be accepted nor any contract entered into without proof of the contractor's and subcontractors' current registration with the Department of Industrial Relations to perform public work. Contractor is directed to review, fill out and execute the Public Works Contractor Registration Certification attached hereto as Exhibit "E" prior to contract execution. Notwithstanding the foregoing, the contractor registration requirements mandated by Labor Code Sections 1725.5 and 1771.1 shall not apply to work performed on a public works project that is exempt pursuant to the small project exemption specified in Labor Code Sections 1725.5 and 1771.1.

3.7.14 Labor Compliance: Stop Orders. This Project is subject to compliance monitoring and enforcement by the Department of Industrial Relations. It shall be the Contractor's sole responsibility to evaluate and pay the cost of complying with all labor compliance requirements under this Contract and applicable law. Any stop orders issued by the Department of Industrial Relations against Contractor or any subcontractor that affect Contractor's performance of Work, including any delay, shall be Contractor's sole responsibility. Any delay arising out of or resulting from such stop orders shall be considered Contractor caused delay subject to any applicable liquidated damages and shall not be compensable by the City. Contractor shall defend, indemnify and hold the City, its officials, officers, employees and agents free and harmless from any claim or liability arising out of stop orders issued by the Department of Industrial Relations against Contractor or any subcontractor.

3.8 Performance of Work: Jobsite Obligations.

3.8.1 Water Quality Management and Compliance.

3.8.1.1 Water Quality Management and Compliance. Contractor shall keep itself and all subcontractors, staff, and employees fully informed of and in compliance with all local, state and federal laws, rules and regulations that may impact, or be implicated by the performance of the Work including, without limitation, all applicable provisions of the Federal Water Pollution Control Act (33 U.S.C. §§ 1300); the California Porter-Cologne Water Quality Control Act (Cal Water Code §§ 13000-14950); local ordinances regulating discharges of storm water; and any and all regulations, policies, or permits issued pursuant to any such authority regulating the discharge of pollutants, as that term is used in the Porter-Cologne Water Quality Control Act, to any ground or surface water in the State.

3.8.1.2 Compliance with the Statewide Construction General Permit. Contractor shall comply with all conditions of the most recent iteration of the National Pollutant Discharge Elimination System General Permit for Storm Water Discharges Associated with Construction Activity, issued by the California State Water Resources Control Board ("Permit"). It shall be Contractor's sole responsibility to file a Notice of Intent and procure coverage under the Permit for all construction activity which results in the disturbance of more than one

acre of total land area or which is part of a larger common area of development or sale. Prior to initiating work, Contractor shall be solely responsible for preparing and implementing a Storm Water Pollution Prevention Plan (SWPPP) as required by the Permit. If required by the City, Contractor shall be responsible for procuring, implementing and complying with the provisions of the Permit and the SWPPP, including the standard provisions, and monitoring and reporting requirements as required by the Permit. The Permit requires the SWPPP to be a "living document" that changes as necessary to meet the conditions and requirements of the job site as it progresses through different phases of construction and is subject to different weather conditions. It shall be Contractor's sole responsibility to update the SWPPP as necessary to address conditions at the project site.

3.8.1.3 Other Water Quality Rules Regulations and Policies. Contractor shall comply with the lawful requirements of any applicable municipality, drainage City, or local agency regarding discharges of storm water to separate storm drain systems or other watercourses under their jurisdiction, including applicable requirements in municipal storm water management programs.

3.8.1.4 Cost of Compliance. Storm, surface, nuisance, or other waters may be encountered at various times during construction of The Work. Therefore, the Contractor, by submitting a Bid, hereby acknowledges that it has investigated the risk arising from such waters, has prepared its Bid accordingly, and assumes any and all risks and liabilities arising therefrom.

3.8.1.5 Liability for Non-Compliance. Failure to comply with the Permit is a violation of federal and state law. Pursuant to the indemnification provisions of this Contract, Contractor hereby agrees to defend, indemnify and hold harmless the City and its officials, officers, employees, volunteers and agents for any alleged violations. In addition, City may seek damages from Contractor for any delay in completing the Work in accordance with the Contract, if such delay is caused by or related to Contractor's failure to comply with the Permit.

3.8.1.6 Reservation of Right to Defend. City reserves the right to defend any enforcement action brought against the City for Contractor's failure to comply with the Permit or any other relevant water quality law, regulation, or policy. Pursuant to the indemnification provisions of this Contract, Contractor hereby agrees to be bound by, and to reimburse the City for the costs (including the City's attorney's fees) associated with, any settlement reached between the City and the relevant enforcement entity.

3.8.1.7 Training. In addition to the standard of performance requirements set forth in paragraph 3.4, Contractor warrants that all employees and subcontractors shall have sufficient skill and experience to perform the Work assigned to them without impacting water quality in violation of the laws, regulations and policies described in paragraph 3.8.1. Contractor further warrants that it, its employees and subcontractors will receive adequate training, as determined by City, regarding the requirements of the laws, regulations and policies described in paragraph 3.8.1 as they may relate to the Work provided under this Agreement. Upon request, City will provide the Contractor with a list of training programs that meet the requirements of this paragraph.

3.8.2 Safety. Contractor shall execute and maintain its work so as to avoid injury or damage to any person or property. Contractor shall comply with the requirements of the specifications relating to safety measures applicable in particular operations or kinds of work. In carrying out its Work, Contractor shall at all times be in compliance with all applicable local, state

and federal laws, rules and regulations, and shall exercise all necessary precautions for the safety of employees appropriate to the nature of the Work and the conditions under which the Work is to be performed. Safety precautions as applicable shall include, but shall not be limited to, adequate life protection and lifesaving equipment; adequate illumination for underground and night operations; instructions in accident prevention for all employees, such as machinery guards, safe walkways, scaffolds, ladders, bridges, gang planks, confined space procedures, trenching and shoring, fall protection and other safety devices, equipment and wearing apparel as are necessary or lawfully required to prevent accidents or injuries; and adequate facilities for the proper inspection and maintenance of all safety measures. Furthermore, Contractor shall prominently display the names and telephone numbers of at least two medical doctors practicing in the vicinity of the Project, as well as the telephone number of the local ambulance service, adjacent to all telephones at the Project site.

3.8.3 Laws and Regulations. Contractor shall keep itself fully informed of and in compliance with all local, state and federal laws, rules and regulations in any manner affecting the performance of the Contract or the Work, including all Cal/OSHA requirements, and shall give all notices required by law. Contractor shall be liable for all violations of such laws and regulations in connection with Work. If Contractor observes that the drawings or specifications are at variance with any law, rule or regulation, it shall promptly notify the City in writing. Any necessary changes shall be made by written change order. If Contractor performs any work knowing it to be contrary to such laws, rules and regulations and without giving written notice to the City, Contractor shall be solely responsible for all costs arising therefrom. City is a public entity of the State of California subject to certain provisions of the Health & Safety Code, Government Code, Public Contract Code, and Labor Code of the State. It is stipulated and agreed that all provisions of the law applicable to the public contracts of a municipality are a part of this Contract to the same extent as though set forth herein and will be complied with. Contractor shall defend, indemnify and hold City, its officials, officers, employees and agents free and harmless, pursuant to the indemnification provisions of this Contract, from any claim or liability arising out of any failure or alleged failure to comply with such laws, rules or regulations.

3.8.4 Permits and Licenses. Contractor shall be responsible for securing City permits and licenses necessary to perform the Work described herein, including, but not limited to, any required business license. While Contractor will not be charged a fee for any City permits, Contractor shall pay the City's business license fee, if any. Any ineligible contractor or subcontractor pursuant to Labor Code Sections 1777.1 and 1777.7 may not perform work on this Project.

3.8.5 Trenching Work. If the Total Contract Price exceeds \$25,000 and if the Work governed by this Contract entails excavation of any trench or trenches five (5) feet or more in depth, Contractor shall comply with all applicable provisions of the California Labor Code, including Section 6705. To this end, Contractor shall submit for City's review and approval a detailed plan showing the design of shoring, bracing, sloping, or other provisions to be made for worker protection from the hazard of caving ground during the excavation of such trench or trenches. If such plan varies from the shoring system standards, the plan shall be prepared by a registered civil or structural engineer.

3.8.6 Hazardous Materials and Differing Conditions. As required by California Public Contract Code Section 7104, if this Contract involves digging trenches or other excavations that extend deeper than four (4) feet below the surface, Contractor shall promptly, and prior to disturbance of any conditions, notify City of: (1) any material discovered in excavation that Contractor believes to be a hazardous waste that is required to be removed to a Class I, Class II

or Class III disposal site; (2) subsurface or latent physical conditions at the site differing from those indicated by City; and (3) unknown physical conditions of an unusual nature at the site, significantly different from those ordinarily encountered in such contract work. Upon notification, City shall promptly investigate the conditions to determine whether a change order is appropriate. In the event of a dispute, Contractor shall not be excused from any scheduled completion date and shall proceed with all Work to be performed under the Contract, but shall retain all rights provided by the Contract or by law for making protests and resolving the dispute.

3.8.7 Underground Utility Facilities. To the extent required by Section 4215 of the California Government Code, City shall compensate Contractor for the costs of: (1) locating and repairing damage to underground utility facilities not caused by the failure of Contractor to exercise reasonable care; (2) removing or relocating underground utility facilities not indicated in the construction drawings; and (3) equipment necessarily idled during such work. Contractor shall not be assessed liquidated damages for delay caused by failure of City to provide for removal or relocation of such utility facilities.

3.8.8 Air Quality. Contractor must fully comply with all applicable laws, rules and regulations in furnishing or using equipment and/or providing services, including, but not limited to, emissions limits and permitting requirements imposed by the California Air Resources Board (CARB). Although CARB limits and requirements are more broad, Contractor shall specifically be aware of their application to "portable equipment", which definition is considered by CARB to include any item of equipment with a fuel-powered engine. Contractor shall indemnify City against any fines or penalties imposed by CARB, or any other governmental or regulatory agency for violations of applicable laws, rules and/or regulations by Contractor, its subcontractors, or others for whom Contractor is responsible under its indemnity obligations provided for in this Agreement.

3.8.9 State Recycling Mandates. Contractor shall comply with State Recycling Mandates. Any recyclable materials/debris collected by the contractor that can be feasibly diverted via reuse or recycling must be hauled by the appropriate handler for reuse or recycling.

3.9 Completion of Work. When Contractor determines that it has completed the Work required herein, Contractor shall so notify City in writing and shall furnish all labor and material releases required by this Contract. City shall thereupon inspect the Work. If the Work is not acceptable to the City, the City shall indicate to Contractor in writing the specific portions or items of Work which are unsatisfactory or incomplete. Once Contractor determines that it has completed the incomplete or unsatisfactory Work, Contractor may request a reinspection by the City. Once the Work is acceptable to City, City shall pay to Contractor the Total Contract Price remaining to be paid, less any amount which City may be authorized or directed by law to retain. Payment of retention proceeds due to Contractor shall be made in accordance with Section 7107 of the California Public Contract Code.

3.10 Claims: Government Code Claim Compliance.

3.10.1 Intent. Effective January 1, 1991, Section 20104 et seq., of the California Public Contract Code prescribes a process utilizing informal conferences, non-binding judicial supervised mediation, and judicial arbitration to resolve disputes on construction claims of \$375,000 or less. Effective January 1, 2017, Section 9204 of the Public Contract Code prescribes a process for negotiation and mediation to resolve disputes on construction claims. The intent of this Section is to implement Sections 20104 et seq. and Section 9204 of the California Public Contract Code. This Section shall be construed to be consistent with said statutes.

3.10.2 Claims. For purposes of this Section, "Claim" means a separate demand by the Contractor, after a change order duly requested in accordance with the terms of this Contract has been denied by the City, for (A) a time extension, (B) payment of money or damages arising from Work done by or on behalf of the Contractor pursuant to the Contract, or (C) an amount the payment of which is disputed by the City. A "Claim" does not include any demand for payment for which the Contractor has failed to provide notice, request a change order, or otherwise failed to follow any procedures contained in the Contract Documents. Claims governed by this Section may not be filed unless and until the Contractor completes all procedures for giving notice of delay or change and for the requesting of a time extension or change order, including but not necessarily limited to the change order procedures contained herein, and Contractor's request for a change has been denied in whole or in part. Claims governed by this Section must be filed no later than fourteen (14) days after a request for change has been denied in whole or in part or after any other event giving rise to the Claim. The Claim shall be submitted in writing to the City and shall include on its first page the following in 16 point capital font: "THIS IS A CLAIM." Furthermore, the claim shall include the documents necessary to substantiate the claim. Nothing in this Section is intended to extend the time limit or supersede notice requirements otherwise provided by contract for the filing of claims, including all requirements pertaining to compensation or payment for extra Work, disputed Work, and/or changed conditions. Failure to follow such contractual requirements shall bar any claims or subsequent lawsuits for compensation or payment thereon.

3.10.3 Supporting Documentation. The Contractor shall submit all claims in the following format:

3.10.3.1 Summary of claim merit and price, reference Contract Document provisions pursuant to which the claim is made

3.10.3.2 List of documents relating to claim:

- (A) Specifications
- (B) Drawings
- (C) Clarifications (Requests for Information)
- (D) Schedules
- (E) Other

3.10.3.3 Chronology of events and correspondence

3.10.3.4 Analysis of claim merit

3.10.3.5 Analysis of claim cost

3.10.3.6 Time impact analysis in CPM format

3.10.3.7 If Contractor's claim is based in whole or in part on an allegation of errors or omissions in the Drawings or Specifications for the Project, Contractor shall provide a summary of the percentage of the claim subject to design errors or omissions and shall obtain a certificate of merit in support of the claim of design errors and omissions.

3.10.3.8 Cover letter and certification of validity of the claim, including any claims from subcontractors of any tier, in accordance with Government Code section 12650 *et seq.*

3.10.4 City's Response. Upon receipt of a claim pursuant to this Section, City shall conduct a reasonable review of the claim and, within a period not to exceed 45 days, shall provide the Contractor a written statement identifying what portion of the claim is disputed and what portion is undisputed. Any payment due on an undisputed portion of the claim will be processed and made within 60 days after the public entity issues its written statement.

3.10.4.1 If City needs approval from its governing body to provide the Contractor a written statement identifying the disputed portion and the undisputed portion of the claim, and the governing body does not meet within the 45 days or within the mutually agreed to extension of time following receipt of a claim sent by registered mail or certified mail, return receipt requested, City shall have up to three days following the next duly publicly noticed meeting of the governing body after the 45-day period, or extension, expires to provide the Contractor a written statement identifying the disputed portion and the undisputed portion.

3.10.4.2 Within 30 days of receipt of a claim, City may request in writing additional documentation supporting the claim or relating to defenses or claims City may have against the Contractor. If additional information is thereafter required, it shall be requested and provided pursuant to this subdivision, upon mutual agreement of City and the Contractor.

3.10.4.3 City's written response to the claim, as further documented, shall be submitted to the Contractor within 30 days (if the claim is less than \$50,000, within 15 days) after receipt of the further documentation, or within a period of time no greater than that taken by the Contractor in producing the additional information or requested documentation, whichever is greater.

3.10.5 Meet and Confer. If the Contractor disputes City's written response, or City fails to respond within the time prescribed, the Contractor may so notify City, in writing, either within 15 days of receipt of City's response or within 15 days of City's failure to respond within the time prescribed, respectively, and demand an informal conference to meet and confer for settlement of the issues in dispute. Upon receipt of a demand, City shall schedule a meet and confer conference within 30 days for settlement of the dispute.

3.10.6 Mediation. Within 10 business days following the conclusion of the meet and confer conference, if the claim or any portion of the claim remains in dispute, City shall provide the Contractor a written statement identifying the portion of the claim that remains in dispute and the portion that is undisputed. Any payment due on an undisputed portion of the claim shall be processed and made within 60 days after City issues its written statement. Any disputed portion of the claim, as identified by the Contractor in writing, shall be submitted to nonbinding mediation, with City and the Contractor sharing the associated costs equally. City and Contractor shall mutually agree to a mediator within 10 business days after the disputed portion of the claim has been identified in writing, unless the parties agree to select a mediator at a later time.

3.10.6.1 If the Parties cannot agree upon a mediator, each Party shall select a mediator and those mediators shall select a qualified neutral third party to mediate with regard to the disputed portion of the claim. Each Party shall bear the fees and costs charged by its respective mediator in connection with the selection of the neutral mediator.

3.10.6.2 For purposes of this section, mediation includes any nonbinding process, including, but not limited to, neutral evaluation or a dispute review board, in which an independent third party or board assists the Parties in dispute resolution through negotiation or by issuance of an evaluation. Any mediation utilized shall conform to the timeframes in this section.

3.10.6.3 Unless otherwise agreed to by City and the Contractor in writing, the mediation conducted pursuant to this section shall excuse any further obligation under Section 20104.4 to mediate after litigation has been commenced.

3.10.6.4 The mediation shall be held no earlier than the date the Contractor completes the Work or the date that the Contractor last performs Work, whichever is earlier. All unresolved claims shall be considered jointly in a single mediation, unless a new unrelated claim arises after mediation is completed.

3.10.7 Procedures After Mediation. If following the mediation, the claim or any portion remains in dispute, the Contractor must file a claim pursuant to Chapter 1 (commencing with Section 900) and Chapter 2 (commencing with Section 910) of Part 3 of Division 3.6 of Title 1 of the Government Code. For purposes of those provisions, the running of the period of time within which a claim must be filed shall be tolled from the time the Contractor submits his or her written claim pursuant to subdivision (a) until the time the claim is denied, including any period of time utilized by the meet and confer conference or mediation.

3.10.8 Civil Actions. The following procedures are established for all civil actions filed to resolve claims subject to this Section:

3.10.8.1 Within 60 days, but no earlier than 30 days, following the filing or responsive pleadings, the court shall submit the matter to non-binding mediation unless waived by mutual stipulation of both parties or unless mediation was held prior to commencement of the action in accordance with Public Contract Code section 9204 and the terms of these procedures. The mediation process shall provide for the selection within 15 days by both parties of a disinterested third person as mediator, shall be commenced within 30 days of the submittal, and shall be concluded within 15 days from the commencement of the mediation unless a time requirement is extended upon a good cause showing to the court.

3.10.8.2 If the matter remains in dispute, the case shall be submitted to judicial arbitration pursuant to Chapter 2.5 (commencing with Section 1141.10) of Title 3 of Part 3 of the Code of Civil Procedure, notwithstanding Section 1114.11 of that code. The Civil Discovery Act of 1986 (Article 3 (commencing with Section 2016) of Chapter 3 of Title 3 of Part 4 of the Code of Civil Procedure) shall apply to any proceeding brought under this subdivision consistent with the rules pertaining to judicial arbitration.

3.10.8.3 In addition to Chapter 2.5 (commencing with Section 1141.10) of Title 3 of Part 3 of the Code of Civil Procedure, (A) arbitrators shall, when possible, be experienced in construction law, and (B) any party appealing an arbitration award who does not obtain a more favorable judgment shall, in addition to payment of costs and fees under that chapter, also pay the attorney's fees on appeal of the other party.

3.10.9 Government Code Claims. In addition to any and all contract requirements pertaining to notices of and requests for compensation or payment for extra work, disputed work, claims and/or changed conditions, Contractor must comply with the claim procedures set forth in Government Code sections 900 et seq. prior to filing any lawsuit against the City. Such

Government Code claims and any subsequent lawsuit based upon the Government Code claims shall be limited to those matters that remain unresolved after all procedures pertaining to extra work, disputed work, claims, and/or changed conditions have been followed by Contractor. If no such Government Code claim is submitted, or if any prerequisite contractual requirements are not otherwise satisfied as specified herein, Contractor shall be barred from bringing and maintaining a valid lawsuit against the City. A Government Code claim must be filed no earlier than the date the work is completed or the date the Contractor last performs work on the Project, whichever occurs first. A Government Code claim shall be inclusive of all unresolved claims unless a new unrelated claim arises after the Government Code claim is submitted.

3.10.10 Non-Waiver. City's failure to respond to a claim from the Contractor within the time periods described in this Section or to otherwise meet the time requirements of this Section shall result in the claim being deemed rejected in its entirety. City's failure to respond shall not waive City's rights to any subsequent procedures for the resolution of disputed claims.

3.11 Loss and Damage. Except as may otherwise be limited by law, Contractor shall be responsible for all loss and damage which may arise out of the nature of the Work agreed to herein, or from the action of the elements, or from any unforeseen difficulties which may arise or be encountered in the prosecution of the Work until the same is fully completed and accepted by City. In the event of damage proximately caused by an Act of God, as defined by Section 7105 of the Public Contract Code, the City may terminate this Contract pursuant to Section 3.17.3; provided, however, that the City needs to provide Contractor with only one (1) day advanced written notice.

3.12 Indemnification.

3.12.1 Scope of Indemnity. To the fullest extent permitted by law, Contractor shall defend (with counsel reasonably approved by City), indemnify and hold the City, its officials, employees, agents and authorized volunteers free and harmless from any and all claims, demands, causes of action, suits, actions, proceedings, costs, expenses, liability, judgments, awards, decrees, settlements, loss, damage or injury of any kind, in law or equity, to property or persons, including wrongful death, (collectively, "Claims") in any manner arising out of, pertaining to, or incident to any alleged acts, errors or omissions, or willful misconduct of Contractor, its officials, officers, employees, subcontractors, consultants or agents in connection with the performance of the Contractor's services, the Project or this Agreement, including without limitation the payment of all consequential damages, expert witness fees and attorneys' fees and other related costs and expenses. Notwithstanding the foregoing, to the extent required by Civil Code section 2782, Contractor's indemnity obligation shall not apply to liability for damages for death or bodily injury to persons, injury to property, or any other loss, damage or expense arising from the sole or active negligence or willful misconduct of the City or the City's agents, servants, or independent contractors who are directly responsible to the City, or for defects in design furnished by those persons.

3.12.2 Additional Indemnity Obligations. In addition, Contractor shall pay and satisfy any judgment, award or decree that may be rendered against City or its officials, employees, agents and authorized volunteers as part of any such claim, suit, action or other proceeding. Contractor shall also reimburse City for the cost of any settlement paid by City or its officials, employees, agents and authorized volunteers as part of any such claim, suit, action or other proceeding. Such reimbursement shall include payment for City's attorney's fees and costs, including expert witness fees. Contractor shall reimburse City and its officials, employees, agents and authorized volunteers, for any and all legal expenses and costs incurred by each of them in

connection therewith or in enforcing the indemnity herein provided. Contractor's obligation to indemnify shall not be restricted to insurance proceeds, if any, received by the City, its officials, employees, agents and authorized volunteers.

3.13 Insurance. Contractor agrees to procure and maintain, at Contractor's expense all insurance specified in Exhibit "H" attached hereto and by this reference incorporated herein. Contractor shall require all subcontractors to carry the same policies and limits of insurance that the Contractor is required to maintain, unless otherwise approved in writing by the City.

3.13.1

3.14 Bond Requirements.

3.14.1 Payment Bond. If required by law or otherwise specifically requested by City in Exhibit "C" attached hereto and incorporated herein by reference, Contractor shall execute and provide to City concurrently with this Contract a Payment Bond in an amount required by the City and in a form provided or approved by the City. If such bond is required, no payment will be made to Contractor until the bond has been received and approved by the City.

3.14.2 Performance Bond. If specifically requested by City in Exhibit "C" attached hereto and incorporated herein by reference, Contractor shall execute and provide to City concurrently with this Contract a Performance Bond in an amount required by the City and in a form provided or approved by the City. If such bond is required, no payment will be made to Contractor until the bond has been received and approved by the City.

3.14.3 Bond Provisions. Should, in City's sole opinion, any bond become insufficient or any surety be found to be unsatisfactory, Contractor shall renew or replace the effected bond within (ten) 10 days of receiving notice from City. In the event the surety or Contractor intends to reduce or cancel any required bond, at least thirty (30) days prior written notice shall be given to the City, and Contractor shall post acceptable replacement bonds at least ten (10) days prior to expiration of the original bonds. No further payments shall be deemed due or will be made under this Contract until any replacement bonds required by this Section are accepted by the City. To the extent, if any, that the Total Contract Price is increased in accordance with the Contract, Contractor shall, upon request of the City, cause the amount of the bond to be increased accordingly and shall promptly deliver satisfactory evidence of such increase to the City. If Contractor fails to furnish any required bond, the City may terminate the Contract for cause.

3.14.4 Surety Qualifications. Only bonds executed by an admitted surety insurer, as defined in California Code of Civil Procedure Section 995.120, shall be accepted. If a California-admitted surety insurer issuing bonds does not meet these requirements, the insurer will be considered qualified if it is in conformance with Section 995.660 of the California Code of Civil Procedure, and proof of such is provided to the City.

3.15 Warranty. Contractor warrants all Work under the Contract (which for purposes of this Section shall be deemed to include unauthorized work which has not been removed and any non-conforming materials incorporated into the Work) to be of good quality and free from any defective or faulty material and workmanship. Contractor agrees that for a period of one year (or the period of time specified elsewhere in the Contract or in any guarantee or warranty provided by any manufacturer or supplier of equipment or materials incorporated into the Work, whichever is later) after the date of final acceptance, Contractor shall within ten (10) days after being notified

Representative"). City's Representative shall have the power to act on behalf of the City for all purposes under this Contract. Contractor shall not accept direction or orders from any person other than the City's Representative or his or her designee.

3.17.2 Contractor's Representative. Before starting the Work, Contractor shall submit in writing the name, qualifications and experience of its proposed representative who shall be subject to the review and approval of the City ("Contractor's Representative"). Following approval by the City, Contractor's Representative shall have full authority to represent and act on behalf of Contractor for all purposes under this Contract. Contractor's Representative shall supervise and direct the Work, using his best skill and attention, and shall be responsible for all construction means, methods, techniques, sequences and procedures and for the satisfactory coordination of all portions of the Work under this Contract. Contractor's Representative shall devote full time to the Project and either he or his designee, who shall be acceptable to the City, shall be present at the Work site at all times that any Work is in progress and at any time that any employee or subcontractor of Contractor is present at the Work site. Arrangements for responsible supervision, acceptable to the City, shall be made for emergency Work which may be required. Should Contractor desire to change its Contractor's Representative, Contractor shall provide the information specified above and obtain the City's written approval.

3.17.3 Termination. This Contract may be terminated by City at any time, either with or without cause, by giving Contractor three (3) days advance written notice. In the event of termination by City for any reason other than the fault of Contractor, City shall pay Contractor for all Work performed up to that time as provided herein. In the event of breach of the Contract by Contractor, City may terminate the Contract immediately without notice, may reduce payment to Contractor in the amount necessary to offset City's resulting damages, and may pursue any other available recourse against Contractor. Contractor may not terminate this Contract except for cause. In the event this Contract is terminated in whole or in part as provided, City may procure, upon such terms and in such manner as it may determine appropriate, services similar to those terminated. Further, if this Contract is terminated as provided, City may require Contractor to provide all finished or unfinished documents, data, diagrams, drawings, materials or other matter prepared or built by Contractor in connection with its performance of this Contract.

3.17.4 Contract Interpretation. Should any question arise regarding the meaning or import of any of the provisions of this Contract or written or oral instructions from City, the matter shall be referred to City's Representative, whose decision shall be binding upon Contractor.

3.17.5 Anti-Trust Claims. This provision shall be operative if this Contract is applicable to California Public Contract Code Section 7103.5. In entering into this Contract to supply goods, services or materials, Contractor hereby offers and agrees to assign to the City all rights, title, and interest in and to all causes of action it may have under Section 4 of the Clayton Act (15 U.S.C. Section 15) or under the Cartwright Act (Chapter 2, commencing with Section 16700, of Part 2 of Division 7 of the Business and Professions Code) arising from purchases of goods, services, or materials pursuant to the Contract. This assignment shall be made and become effective at the time the City tender final payment to Contractor, without further acknowledgment by the Parties.

3.17.6 Notices. All notices hereunder and communications regarding interpretation of the terms of the Contract or changes thereto shall be provided by the mailing thereof by registered or certified mail, return receipt requested, postage prepaid and addressed as follows:

CONTRACTOR:

O'Connell Engineering & Construction, Inc.
36572 Deauville Rd.
Winchester, CA 92596
Attn: Rhonda O'Connell, President

CITY:

City of San Clemente
910 Calle Negocio
San Clemente, CA 92673
Attn: Amir Ilkhanipour, Sr. Civil Engineer

Any notice so given shall be considered received by the other Party three (3) days after deposit in the U.S. Mail as stated above and addressed to the Party at the above address. Actual notice shall be deemed adequate notice on the date actual notice occurred, regardless of the method of service.

3.17.7 Time of Essence. Time is of the essence in the performance of this Contract.

3.17.8 Assignment Forbidden. Contractor shall not, either voluntarily or by action of law, assign or transfer this Contract or any obligation, right, title or interest assumed by Contractor herein without the prior written consent of City. If Contractor attempts an assignment or transfer of this Contract or any obligation, right, title or interest herein, City may, at its option, terminate and revoke the Contract and shall thereupon be relieved from any and all obligations to Contractor or its assignee or transferee.

3.17.9 No Third Party Beneficiaries. There are no intended third party beneficiaries of any right or obligation assumed by the Parties.

3.17.10 Laws, Venue, and Attorneys' Fees. This Agreement shall be interpreted in accordance with the laws of the State of California. If any action is brought to interpret or enforce any term of this Agreement, the action shall be brought in a state or federal court situated in the County of Orange, State of California.

3.17.11 Counterparts. This Contract may be executed in counterparts, each of which shall constitute an original.

3.17.12 Successors. The Parties do for themselves, their heirs, executors, administrators, successors, and assigns agree to the full performance of all of the provisions contained in this Contract.

3.17.13 [Reserved]

3.17.14 Solicitation. Contractor maintains and warrants that it has not employed nor retained any company or person, other than a bona fide employee working solely for Contractor, to solicit or secure this Contract. Further, Contractor warrants that it has not paid nor has it agreed to pay any company or person, other than a bona fide employee working solely for Contractor, any fee, commission, percentage, brokerage fee, gift or other consideration contingent upon or resulting from the award or making of this Contract. For breach or violation of this warranty, City shall have the right to terminate this Contract without liability.

3.17.15 Conflict of Interest. Contractor maintains and warrants that it has not employed nor retained any company or person, other than a bona fide employee working solely for Contractor, to solicit or secure this Agreement. Further, Contractor warrants that it has not paid nor has it agreed to pay any company or person, other than a bona fide employee working solely for Contractor, any fee, commission, percentage, brokerage fee, gift or other consideration contingent upon or resulting from the award or making of this Agreement. For breach or violation of this warranty, City shall have the right to rescind this Agreement without liability. For the term of this Contract, no official, officer or employee of City, during the term of his or her service with City, shall have any direct interest in this Contract, or obtain any present or anticipated material benefit arising therefrom. In addition, Contractor agrees to file, or to cause its employees or subcontractors to file, a Statement of Economic Interest with the City's Filing Officer as required under state law in the performance of the Work.

3.17.16 Certification of License.

3.17.16.1 Contractor certifies that as of the date of execution of this Contract, Contractor has a current contractor's license of the classification indicated below under Contractor's signature.

3.17.16.2 Contractors are required by law to be licensed and regulated by the Contractors' State License Board which has jurisdiction to investigate complaints against contractors if a complaint regarding a patent act or omission is filed within four (4) years of the date of the alleged violation. A complaint regarding a latent act or omission pertaining to structural defects must be filed within ten (10) years of the date of the alleged violation. Any questions concerning a contractor may be referred to the Registrar, Contractors' State License Board, P.O. Box 26000, Sacramento, California 95826.

3.17.17 Authority to Enter Contract. Each Party warrants that the individuals who have signed this Contract have the legal power, right and authority to make this Contract and bind each respective Party.

3.17.18 Entire Contract: Modification. This Contract contains the entire agreement of the Parties with respect to the subject matter hereof, and supersedes all prior negotiations, understandings or agreements. This Contract may only be modified by a writing signed by both Parties.

3.17.19 Non-Waiver. None of the provisions of this Agreement shall be considered waived by either party, unless such waiver is specifically specified in writing.

3.17.20 City's Right to Employ Other Contractors. City reserves right to employ other contractors in connection with this Project or other projects.

[SIGNATURES ON NEXT PAGE]

IN WITNESS WHEREOF, the parties hereto have caused this Agreement to be duly executed on the respective dates set forth opposite of their signatures.

CITY OF SAN CLEMENTE

By: [Signature]

Its: City manager

Dated: 2/14, 20 22

ATTEST:

[Signature]
CITY CLERK of the City of San Clemente, California legislative Administrator

APPROVED AS TO FORM:
BEST BEST & KRIEGER

[Signature]
City Attorney

APPROVED AS TO AVAILABILITY
OF FUNDING:

[Signature]
Finance Authorization

O'Connell Engineering & Construction, Inc.
("CONTRACTOR")

By: [Signature]
Rhonda O'Connell

Its: President

Dated: 2-8, 20 22

EXHIBIT "A"
SERVICES / SCHEDULE

See Exhibit "B" for Services

EXHIBIT "B"
PLANS AND SPECIFICATIONS



City of San Clemente

910 Calle Negocio, Suite 100
San Clemente, CA 92673
Tel (949) 361-6100
Fax (949) 361-8316

LOCATION MAP

117 CAPISTRANO LANE
SANITARY SEWER LINE REPAIR
P.N. 24200

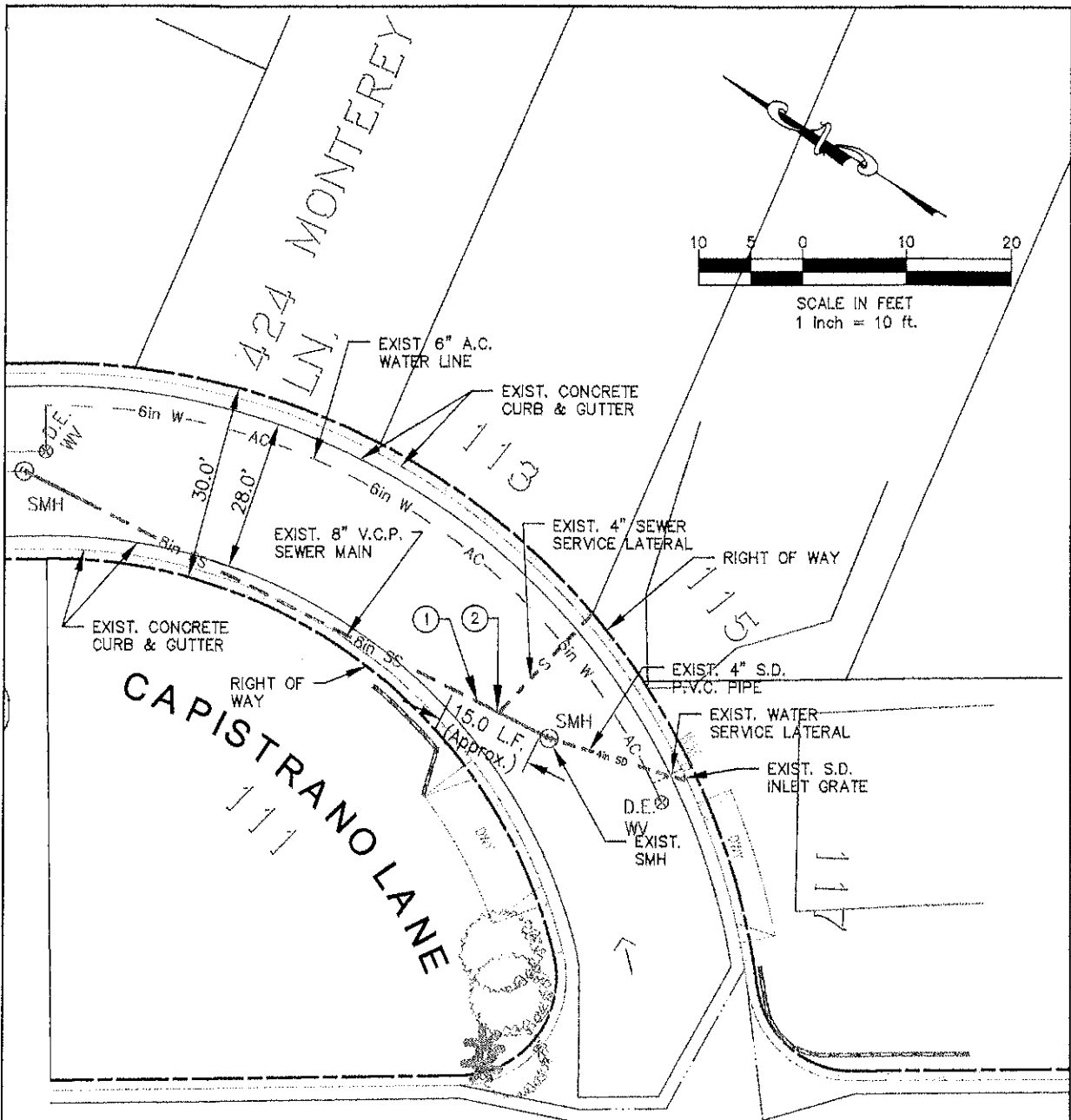

SANTA ANA LN.

CONSTRUCTION NOTES:

- ① REMOVE EXISTING 8" V.C.P. SANITARY SEWER LINE (15.0 L.F. APPROX.) AND REPLACE WITH 8" P.V.C., S.D.R. 26 PIPE, CONNECT NEW PIPE TO EXIST. S.S. LINE USING FLEXIBLE TRANSITION COUPLING ADAPTOR (12-IN. LONG) PER CITY STD. W-16. CONNECT NEW PIPE TO EXIST. SANITARY SEWER MANHOLE PER CITY STD. S-3. PIPE BEDDING AND TRENCH REPAIR PER CITY STD. W-18.
- ② RECONNECT EXISTING 4" (VERIFY DIAM.) SANITARY SEWER SERVICE LATERAL TO NEW 8" S.S. LINE PER CITY STD. S-6.

S:\Work\Engineering\Sanita\17002127\17002127.dwg - Capistrano Lane 15' Right-of-Way - 8" Sewer\17002127.dwg Monday, December 13, 2021 4:26:08 PM

ENGINEERING SCALE : AS SHOWN		DATE:
DRAWN BY : A.C.C.	DESIGNED BY : A.C.C.	12/13/21
CHECKED BY : A.I.		12/13/21
APPROVED :		12/13/21
D.T. REBENS DORF RCE C60091 UTILITIES DIRECTOR		DATE



PLAN
117 CAPISTRANO LANE SANITARY SEWER LINE REPAIR P.N. 24200
CITY OF SAN CLEMENTE

④ CAPISTRANO LANE
 Ref. F.B No 2-59

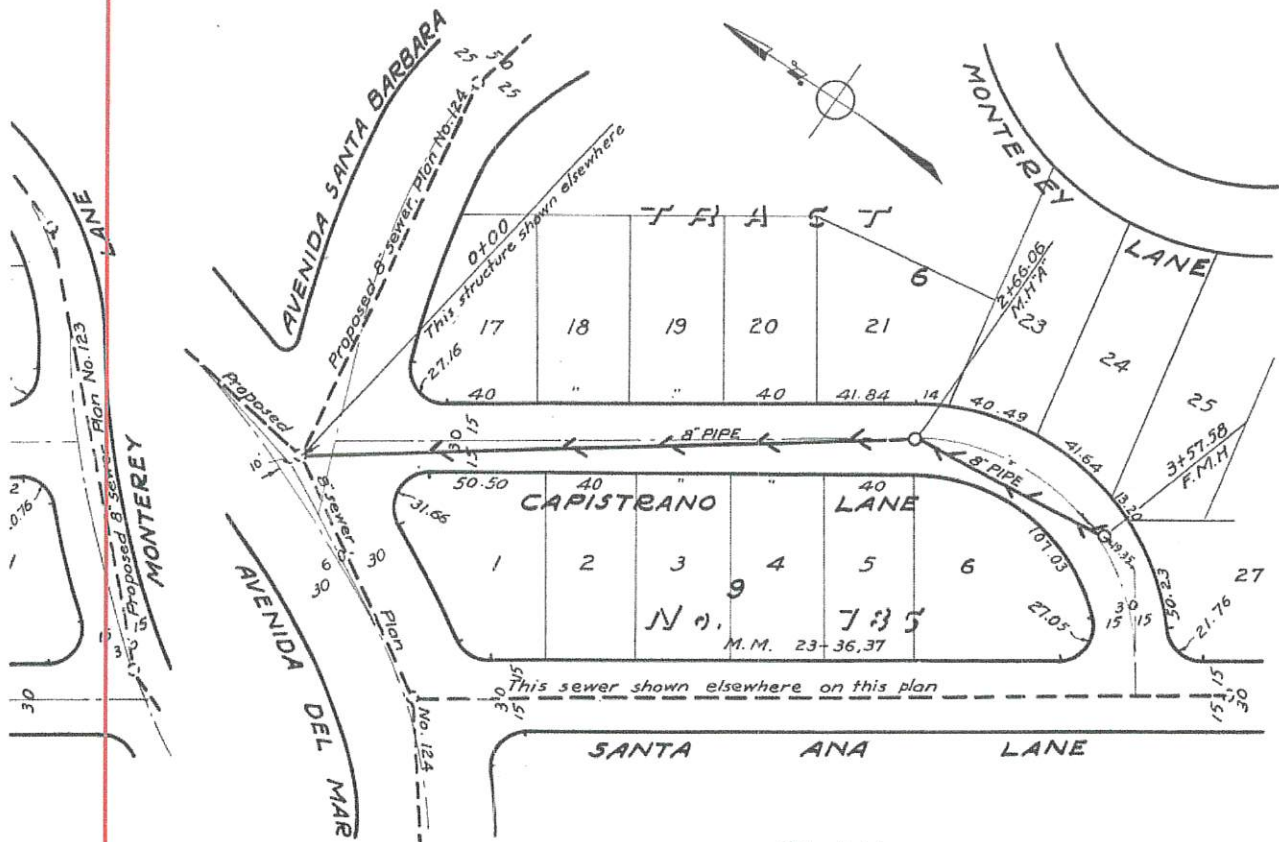
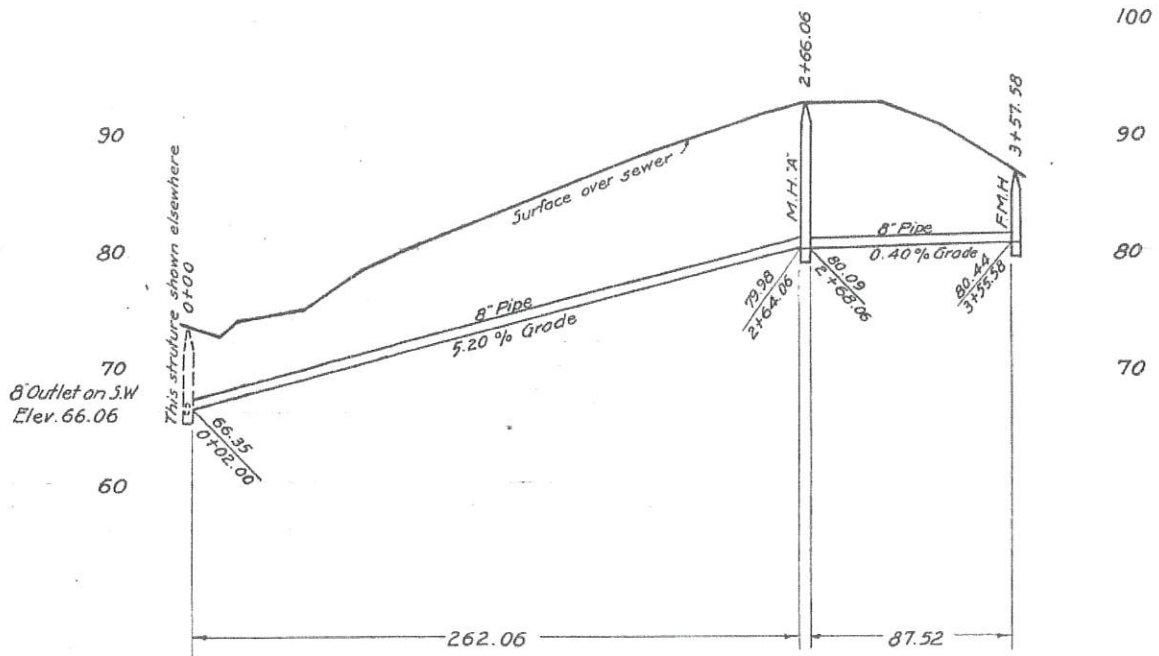

PLAN
 Scale - 1" = 40'

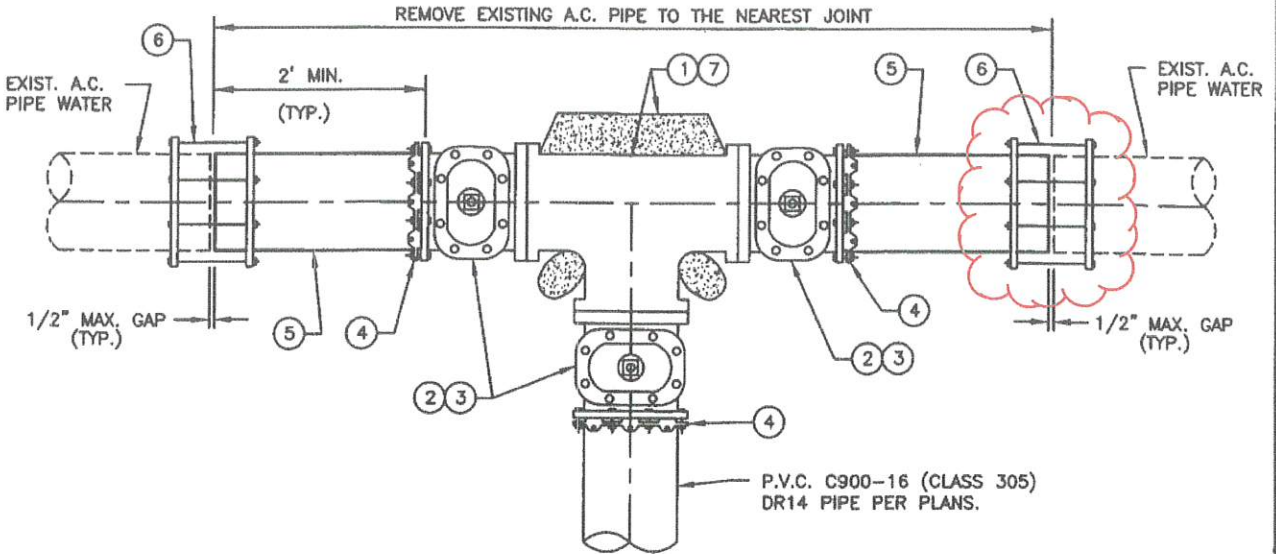

PLAN
N.T.S.

CONSTRUCTION ITEMS / MATERIALS LIST

ITEM No.	CONSTRUCTION ITEMS	MANUFACTURER	MFR. CAT. NO. OR SPEC.
①	FLANGED D.I. TEE W/ THRUST BLOCK PER CITY STD. No. W-6.	TYLER UNION/EBAA	
②	FLxFL RW GATE VALVE PER CITY STD. No. W-4.	MUELLER	2360 SERIES
③	VALVE AND VALVE BOX ASSEMBLY PER CITY STD. No. W-4	TYLER/BINGHAM & TAYLOR	6855 SERIES/3-PC. 5-1/4" V. BOX
④	RESTRAINED FLANGE ADAPTOR.	HYMAX/EBAA/S-B/FORD/ROMAC/STAR	
⑤	P.V.C. C900-16 (CLASS 305) DR14 PIPE.		
⑥	FLEX TRANSITION COUPLING (12" LONG MIN.)	HYMAX/S-B/FORD/ROMAC	
⑦	ZINC ANODE EARNEST CORROSION CONTROL	FARWEST CORROSION CONTROL	ZUR 15

NOTES:

- ALL BOLTS, NUTS, AND WASHERS SHALL BE 316 STAINLESS STEEL AND TORQUED TO MANUFACTURER' SPECIFICATIONS.
- ALL BURIED VALVES, DUCTILE IRON PIPE AND FITTINGS SHALL BE DOUBLE WRAPPED WITH 8 MIL PLASTIC AND 10 MIL TAPE.
- COPPER TRACER WIRE SHALL BE INSTALLED ON TOP OF ALL NON-METALLIC PIPELINES AND ATTACHED W/ ADHESIVE TAPE TO EXIST. TRACER WIRE FOR MAIN OR NUT/BOLT ON TEE. THE COPPER WIRE SHALL BE #12 Cu. WITH HMWPE INSULATION.
- ALL WATER MAINS, WATER SERVICES, ATTACHED APPURTENANCES, AND CONNECTIONS SHALL BE DISINFECTED IN ACCORDANCE WITH AWWA C651 AND AS SPECIFIED IN THE CITY OF SAN CLEMENTE STANDARD PROVISIONS. THE CONTRACTOR SHALL FURNISH ALL EQUIPMENT IN GOOD OPERATING CONDITION, LABOR AND MATERIAL, AND WATER NECESSARY FOR CHLORINATING AND FLUSHING THE PIPELINE AND FOR CERTIFICATION OF THE PIPELINE DISINFECTION, INCLUDING REQUIRED BAC-T AND HPC TESTS. THESE LATTER TESTS SHALL BE DONE AT CITY APPROVED LABORATORIES.
- ALL D.I. PRODUCTS SHALL BE MANUFACTURED IN A U.S.A. FOUNDRY.

APPROVED BY:

C60091
D.T. REBENSORF, UTILITIES DIRECTOR R.C.E. NO. DATE



City of San Clemente
Public Works Department - Engineering Division

1	REVISED STD. DRAWING	K.L.	9/4/15
MARK	REVISIONS	APPR.	DATE

**CUT-IN TEE FOR EXISTING
A.C. PIPE**

STD. NO.

W-16
Sht. 1 of 2

\\CF\data\graphics\Graphics_CD\AutoCAD Engr Drawings\Standards\Standard Provisions & Dwggs\Sewer & Water Std\W-18.dwg 8/28/2020 1:23:09 PM

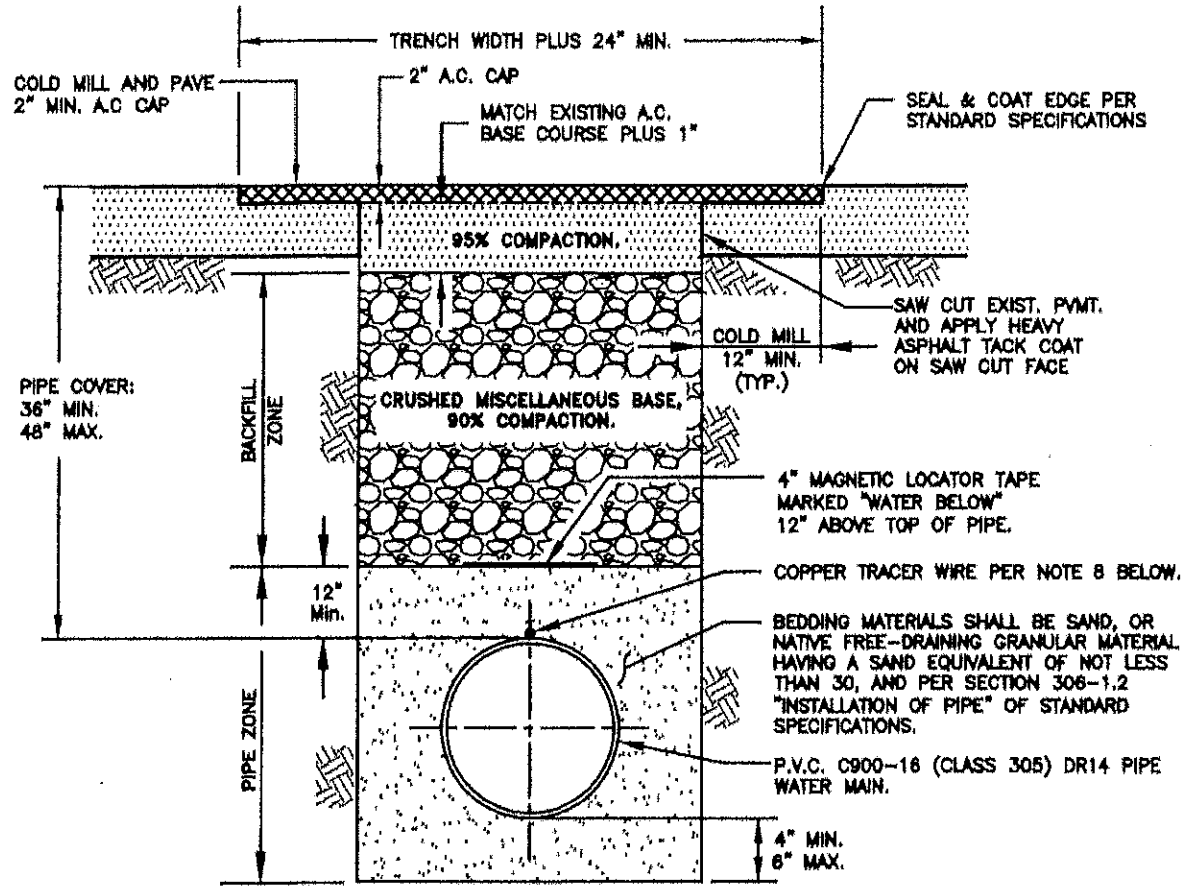

NOTES:

1. ALL TRENCHING AND BACKFILL SHALL BE DONE IN ACCORDANCE WITH SECTION 306, STANDARD SPECIFICATIONS, EXCEPT THAT THE BACKFILL ZONE SHALL BE COMPACTED TO A MINIMUM 90% COMPACTION.
2. IF THE EDGE OF THE TRENCH IS WITHIN 3 FT. OF THE GUTTER, COLD MILL AND PAVE ALL THE WAY TO EDGE OF THE GUTTER.
3. TRENCHES ON COLLECTOR AND ARTERIAL STREETS SHALL BE GROUND FULL WIDTH OF A TRAVEL LANE.
4. TRENCH RESTORATION SHALL INCLUDE RESTORATION IN KIND OF ALL EXISTING IMPROVEMENTS REMOVED AND/OR DISTURBED BY THIS WORK, INCLUDING BUT NOT LIMITED TO SPEED BUMPS AND TRAFFIC LOOPS.
5. A.C. CAP SHALL BE PLACED NO LATER THAN 5 WORKING DAYS AFTER BASE COURSE. APPLY TACK BEFORE PLACING A.C. CAP.
6. A.C. BASE COURSE SHALL BE 3/4" TYPE III, B2-PG 70-10. A.C. CAP SHALL BE 1/2" TYPE III, C2-PG 64-10 PER OC PUBLIC WORKS DEPARTMENT STANDARD PLAN 1805.
7. CRUSHED MISCELLANEOUS BASE (C.M.B.) SHALL BE PER SECTION 200-2.4 OF S.S.P.W.C. (GREEN BOOK).
8. COPPER TRACER WIRE SHALL BE INSTALLED ON TOP OF ALL NON-METALLIC PIPELINES AND ATTACHED W/ PLASTIC ADHESIVE TAPE TO EXIST. TRACER WIRE FOR MAIN OR NUT/BOLT ON TEE. THE COPPER WIRE SHALL BE #12 Cu. WITH HWIPE INSULATION.
9. RECESSED STEEL PLATES ARE REQUIRED AFTER EXCAVATION WHEN TRENCHES ARE NOT READY FOR BACKFILLING OPERATIONS OR MUST REMAIN OPEN FOR FURTHER WORK BEFORE RESTORATION CAN COMMENCE.

APPROVED BY: _____
 C60091
 D.T. REBENSORF, UTILITIES DIRECTOR R.C.E. NO. _____ DATE _____

City of San Clemente

Public Works Department - Engineering Division

MARK	REVISIONS	APPR.	DATE

Water Main Installation,
Trench Backfill and
Roadway Repair

STD. NO.

W-18

PIPE SHALL BE LAID WITH END SQUARE INTO M.H. BASE, UNLESS OTHERWISE NOTED. CONSTRUCT FILLET SHELF OVER PIPE TO DRAIN

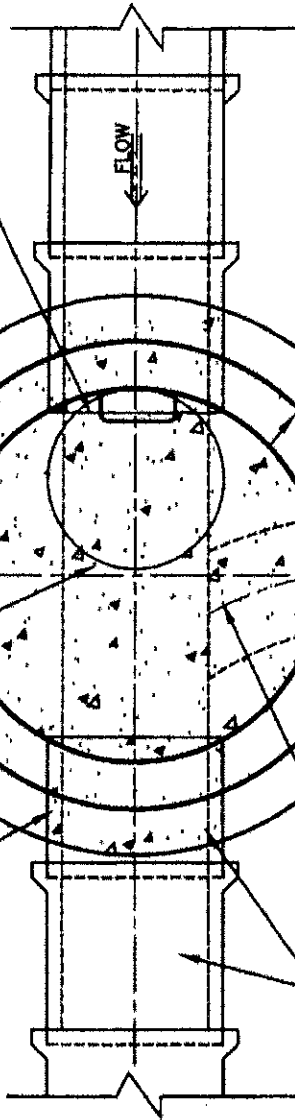

1/8 D

CAST IN PLACE VCP
LATERALS IF REQUIRED
OR PVC FITTING FOR

CENTER SHAFT OPENING
OVER PIPE UPSTREAM
SIDE

8" MIN.
CONC. ENCASE
(INCLUDING BELL)

CAST IN BASE VCP
OR PVC STUB IN OR
OUT AS SHOWN

R = 2D

2-2' JOINTS AT BOTH
INLETS AND OUTLETS

D:\standards\stds\8-3.dwg 02/28/00 11:15:00 AM PST

APPROVED BY:

W.E. Cameron
W.E. CAMERON, CITY ENGINEER

23764 6-28-00
R.C.E. NO. DATE



City of San Clemente

Public Works Department - Engineering Division

STD. NO.

Manhole Base Plan

S-3

MARK	REVISIONS	APPR.	DATE

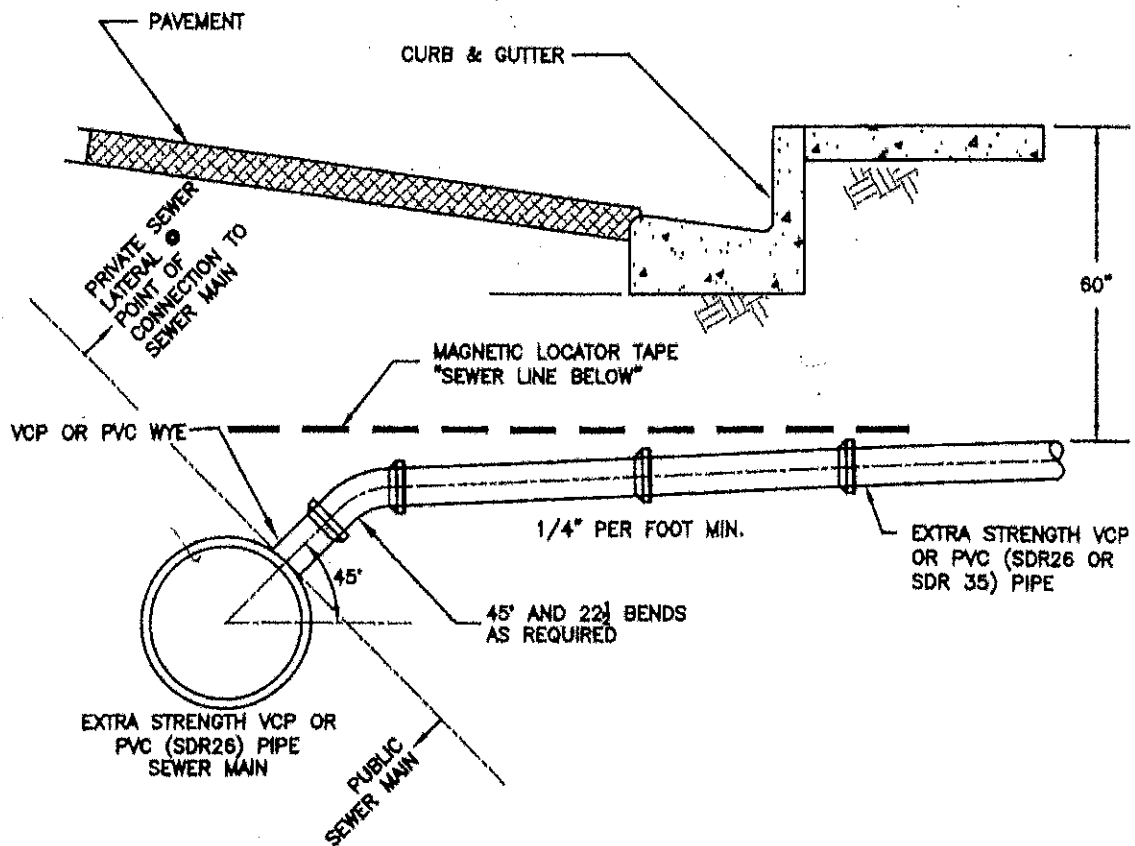

NOTES:

1. MARK SEWER LATERAL WITH A 2" HIGH "S" CHISELED ON TOP OF THE CURB WHERE LATERAL CROSSES UNDER THE CURB AND INSTALL MAGNETIC "CAUTION" TAPE 12 INCHES ABOVE TOP OF THE PIPE.
2. LATERAL SIZE TO BE DETERMINED BY UNIFORM PLUMBING CODE BUT NOT LESS THAN 4" DIAMETER.
3. SEE STANDARD DRAWING WS-1 FOR LATERAL AND MAINLINE BEDDING, TRENCH AND PAVEMENT REPAIR.
4. FOR WYE CONNECTION TO EXISTING MAIN, REFER TO STANDARD DRAWING S-8.

APPROVED BY:

W.E. Cameron
W.E. CAMERON, CITY ENGINEER

23764 6-28-00
R.C.E. NO. DATE



City of San Clemente

Public Works Department - Engineering Division

STD. NO.

House Lateral
Connection

S-6

MARK	REVISIONS	APPR.	DATE

EXHIBIT "C"

SPECIAL CONDITIONS

ARTICLE 1. BONDS

Within ten (10) calendar days from the date the Contractor is notified of award of the Contract, the Contractor shall deliver to the City four identical counterparts of the Performance Bond and Payment Bond on the forms supplied by the City and included as Exhibit "F" to the Contract. Failure to do so may, in the sole discretion of City, result in the forfeiture of Contractor's bid security. The surety supplying the bond must be an admitted surety insurer, as defined in Code of Civil Procedure Section 995.120, authorized to do business as such in the State of California and satisfactory to the City. The Performance Bond and the Payment Bond shall be for one hundred percent (100%) of the Total Contract Price.

Dated: Feb. 8th, 20 22

Consultant

By:

Rhonda O'Connell

President

Title

36572 Deauville Rd.
Address

Winchester, CA 92596

EXHIBIT "E"

PUBLIC WORKS CONTRACTOR REGISTRATION CERTIFICATION

Pursuant to Labor Code sections 1725.5 and 1771.1, all contractors and subcontractors that wish to bid on, be listed in a bid proposal, or enter into a contract to perform public work must be registered with the Department of Industrial Relations. See <http://www.dir.ca.gov/Public-Works/PublicWorks.html> for additional information.

No bid will be accepted nor any contract entered into without proof of the contractor's and subcontractors' current registration with the Department of Industrial Relations to perform public work.

Contractor hereby certifies that it is aware of the registration requirements set forth in Labor Code sections 1725.5 and 1771.1 and is currently registered as a contractor with the Department of Industrial Relations.¹

Name of Contractor: O'Connell Engineering & Construction, Inc.

DIR Registration Number: 1000009021

DIR Registration Expiration: 6/30/22

Small Project Exemption: Yes or No

Unless Contractor is exempt pursuant to the small project exemption, Contractor further acknowledges:

- Contractor shall maintain a current DIR registration for the duration of the project.
- Contractor shall include the requirements of Labor Code sections 1725.5 and 1771.1 in its contract with subcontractors and ensure that all subcontractors are registered at the time of bid opening and maintain registration status for the duration of the project.
- Failure to submit this form or comply with any of the above requirements may result in a finding that the bid is non-responsive.

Name of Contractor O'Connell Engineering & Construction, Inc

Signature 

Name and Title Rhonda O'Connell - President

Dated 02-08-2022

¹ If the Project is exempt from the contractor registration requirements pursuant to the small project exemption under Labor Code Sections 1725.5 and 1771.1, please mark "Yes" in response to "Small Project Exemption."

EXHIBIT "F"
PAYMENT AND PERFORMANCE BONDS

PREMIUM IS FOR THE CONTRACT TERM AND IS SUBJECT TO
ADJUSTMENT BASED ON FINAL CONTRACT PRICE

Bond Number: 24257037

Premium: \$934.00

Executed in Triplicate

PERFORMANCE BOND

KNOW ALL PERSONS BY THESE PRESENTS:

THAT WHEREAS, the City of San Clemente (hereinafter referred to as "City") has awarded to O'Connell Engineering & Construction, Inc. (hereinafter referred to as the "Contractor") an agreement for CAPISTRANO LANE SANITARY SEWER LINE REPAIR, PN 24200 (hereinafter referred to as the "Project").

WHEREAS, the work to be performed by the Contractor is more particularly set forth in the Contract Documents for the Project dated February 11, 2022, (hereinafter referred to as "Contract Documents"), the terms and conditions of which are expressly incorporated herein by reference; and

WHEREAS, the Contractor is required by said Contract Documents to perform the terms thereof and to furnish a bond for the faithful performance of said Contract Documents.

NOW, THEREFORE, we, O'Connell Engineering & Construction, Inc., the undersigned Contractor and The Ohio Casualty Insurance Company as Surety, a corporation organized and duly authorized to transact business under the laws of the State of California, are held and firmly bound unto the City in the sum of Forty Six Thousand Seven Hundred and 00/100 DOLLARS, (\$ 46,700.00), said sum being not less than one hundred percent (100%) of the total amount of the Contract, for which amount well and truly to be made, we bind ourselves, our heirs, executors and administrators, successors and assigns, jointly and severally, firmly by these presents.

THE CONDITION OF THIS OBLIGATION IS SUCH, that, if the Contractor, his or its heirs, executors, administrators, successors or assigns, shall in all things stand to and abide by, and well and truly keep and perform the covenants, conditions and agreements in the Contract Documents and any alteration thereof made as therein provided, on its part, to be kept and performed at the time and in the manner therein specified, and in all respects according to their intent and meaning; and shall faithfully fulfill all obligations including the one-year guarantee of all materials and workmanship; and shall indemnify and save harmless the City, its officers and agents, as stipulated in said Contract Documents, then this obligation shall become null and void; otherwise it shall be and remain in full force and effect.

As a condition precedent to the satisfactory completion of the Contract Documents, unless otherwise provided for in the Contract Documents, the above obligation shall hold good for a period of one (1) year after the acceptance of the work by City, during which time if Contractor shall fail to make full, complete, and satisfactory repair and replacements and totally protect the City from loss or damage resulting from or caused by defective materials or faulty workmanship, Surety shall undertake and faithfully fulfill all such obligations. The obligations of Surety hereunder shall continue so long as any obligation of Contractor remains. Nothing herein shall limit the City's rights or the Contractor or Surety's obligations under the Contract, law or equity, including, but not limited to, California Code of Civil Procedure section 337.15.

Whenever Contractor shall be, and is declared by the City to be, in default under the Contract Documents, the Surety shall remedy the default pursuant to the Contract Documents, or shall promptly, at the City's option:

- (1) Take over and complete the Project in accordance with all terms and conditions in the Contract Documents; or
- (2) Obtain a bid or bids for completing the Project in accordance with all terms and conditions in the Contract Documents and upon determination by Surety of the lowest responsive and responsible bidder, arrange for a Contract between such bidder, the Surety and the City, and make available as work progresses sufficient funds to pay the cost of completion of the Project, less the balance of the contract price, including other costs and damages for which Surety may be liable. The term "balance of the contract price" as used in this paragraph shall mean the total amount payable to Contractor by the City under the Contract and any modification thereto, less any amount previously paid by the City to the Contractor and any other set offs pursuant to the Contract Documents.
- (3) Permit the City to complete the Project in any manner consistent with local, California and federal law and make available as work progresses sufficient funds to pay the cost of completion of the Project, less the balance of the contract price, including other costs and damages for which Surety may be liable. The term "balance of the contract price" as used in this paragraph shall mean the total amount payable to Contractor by the City under the Contract and any modification thereto, less any amount previously paid by the City to the Contractor and any other set offs pursuant to the Contract Documents.

Surety expressly agrees that the City may reject any contractor or subcontractor which may be proposed by Surety in fulfillment of its obligations in the event of default by the Contractor.

Surety shall not utilize Contractor in completing the Project nor shall Surety accept a bid from Contractor for completion of the Project if the City, when declaring the Contractor in default, notifies Surety of the City's objection to Contractor's further participation in the completion of the Project.

The Surety, for value received, hereby stipulates and agrees that no change, extension of time, alteration or addition to the terms of the Contract Documents or to the Project to be performed thereunder shall in any way affect its obligations on this bond, and it does hereby waive notice of any such change, extension of time, alteration or addition to the terms of the Contract Documents or to the Project, including but not limited to the provisions of sections 2819 and 2845 of the California Civil Code.

IN WITNESS WHEREOF, we have hereunto set our hands and seals this 8 day of Feb, 2022.

(Corporate Seal)

O'Connell Engineering & Construction Inc.
Contractor/ Principal

By Rhonda O'Connell
Rhonda O'Connell

Title President

2-8-2022

(Corporate Seal)

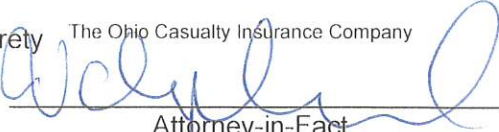
Surety The Ohio Casualty Insurance Company
By 
Attorney-in-Fact

Signatures of those signing for the Contractor and Surety must be notarized and evidence of corporate authority attached.

(Attach Attorney-in-Fact Certificate)

Title Vanessa Copeland, Attorney-in-Fact

The rate of premium on this bond is \$20.00 per thousand. The total amount of premium charges, \$ 934.00.

(The above must be filled in by corporate attorney.)

THIS IS A REQUIRED FORM

Any claims under this bond may be addressed to:

(Name and Address of Surety) The Ohio Casualty Insurance Company
175 Berkeley Street Boston, MA 02116

(Name and Address of Agent or Representative for service of process in California, if different from above) Alliant Insurance Services, Inc.
151 Kalmus Drive, Suite A201, Costa Mesa, CA 92626

(Telephone number of Surety and Agent or Representative for service of process in California) Surety: (617)357-9500
Agent: (714)546-5100

NOTE: A copy of the Power-of-Attorney authorizing the person signing on behalf of the Surety to do so must be attached hereto.

Notary Acknowledgment

A notary public or other officer completing this certificate verifies only the identity of the individual who signed the document to which this certificate is attached, and not the truthfulness, accuracy, or validity of that document.

STATE OF CALIFORNIA
 COUNTY OF See Attached ^{SR} Riverside

On February 8, 2022, before me, Joshua J. Ramberg, Notary Public, personally appeared Rhonda O'Connell _____, who proved to me on the basis of satisfactory

evidence to be the person(s) whose name(s) is/are subscribed to the within instrument and acknowledged to me that he/she/they executed the same in his/her/their authorized capacity(ies), and that by his/her/their signature(s) on the instrument the person(s), or the entity upon behalf of which the person(s) acted, executed the instrument.

I certify under PENALTY OF PERJURY under the laws of the State of California that the foregoing paragraph is true and correct.

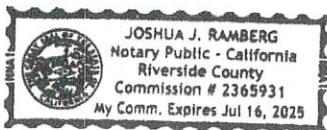

WITNESS my hand and official seal.

Signature of Notary Public

[Handwritten Signature]

OPTIONAL

Though the information below is not required by law, it may prove valuable to persons relying on the document and could prevent fraudulent removal and reattachment of this form to another document.

CAPACITY CLAIMED BY SIGNER

- Individual
- Corporate Officer

- Partner(s)
 - Limited
 - General

- Attorney-In-Fact
- Trustee(s)
- Guardian/Conservator
- Other:

Signer is representing:
 Name Of Person(s) Or Entity(ies)

DESCRIPTION OF ATTACHED DOCUMENT

Performance Bond

Title or Type of Document

3

Number of Pages

Date of Document

Signer(s) Other Than Named Above

CALIFORNIA ALL-PURPOSE ACKNOWLEDGMENT

CIVIL CODE 1189

A notary public or other officer completing this certificate verifies only the identity of the individual who signed the document to which this certificate is attached and not the truthfulness, accuracy, or validity of that document.

State of California)

County of Orange)

On 2/1/20 before me, Lisa Pellerito, Notary Public,

personally appeared Vanessa Copeland
Name(s) of Signer(s)

who proved to me on the basis of satisfactory evidence to be the person(s) whose name(s) is/are subscribed to the within instrument and acknowledged to me that he/she/they executed the same in his/her/their authorized capacity(ies), and that by his/her/their signature(s) on the instrument the person(s), or the entity upon behalf of which the person(s) acted, executed the instrument.



Place Notary Seal Above

I certify under PENALTY OF PERJURY under the laws of the State of California that the foregoing paragraph is true and correct.

WITNESS my hand and official seal.
Signature: [Handwritten Signature]
Signature of Notary Public

OPTIONAL

Though the information below is not required by law, it may prove valuable to persons relying on the document and could present fraudulent and reattachment of this form to another document.

Description of Attached Document

Type or Title of Document:

Document Date: Number of Pages:

Signer(s) Other Than Named Above:

Capacity(ies) Claimed by Signer(s)

Signer's Name: Vanessa Copeland

- Individual
Corporate Officer - Title(s):
Partner: Limited General
Attorney in Fact
Trustee
Guardian or Conservator
Other:

Signer Is Representing:

Capacity(ies) Claimed by Signer(s)

Signer's Name:

- Individual
Corporate Officer - Title(s):
Partner: Limited General
Attorney in Fact
Trustee
Guardian or Conservator
Other:

Signer Is Representing:



This Power of Attorney limits the acts of those named herein, and they have no authority to bind the Company except in the manner and to the extent herein stated.

Liberty Mutual Insurance Company
The Ohio Casualty Insurance Company
West American Insurance Company

Certificate No: 8206873-971958

POWER OF ATTORNEY

KNOWN ALL PERSONS BY THESE PRESENTS: That The Ohio Casualty Insurance Company is a corporation duly organized under the laws of the State of New Hampshire, that Liberty Mutual Insurance Company is a corporation duly organized under the laws of the State of Massachusetts, and West American Insurance Company is a corporation duly organized under the laws of the State of Indiana (herein collectively called the "Companies"), pursuant to and by authority herein set forth, does hereby name, constitute and appoint, Eric Lowey; Kevin Cathcart; Lisa Pellerito; Mark Richardson; Natassia Kirk-Smith; Terah Lane; Vanessa Copeland

all of the city of Costa Mesa state of CA each individually if there be more than one named, its true and lawful attorney-in-fact to make, execute, seal, acknowledge and deliver, for and on its behalf as surety and as its act and deed, any and all undertakings, bonds, recognizances and other surety obligations, in pursuance of these presents and shall be as binding upon the Companies as if they have been duly signed by the president and attested by the secretary of the Companies in their own proper persons.

IN WITNESS WHEREOF, this Power of Attorney has been subscribed by an authorized officer or official of the Companies and the corporate seals of the Companies have been affixed thereto this 2nd day of December, 2021.



Liberty Mutual Insurance Company
The Ohio Casualty Insurance Company
West American Insurance Company

By: David M. Carey, Assistant Secretary

State of PENNSYLVANIA
County of MONTGOMERY

On this 2nd day of December, 2021 before me personally appeared David M. Carey, who acknowledged himself to be the Assistant Secretary of Liberty Mutual Insurance Company, The Ohio Casualty Company, and West American Insurance Company, and that he, as such, being authorized so to do, execute the foregoing instrument for the purposes therein contained by signing on behalf of the corporations by himself as a duly authorized officer.

IN WITNESS WHEREOF, I have hereunto subscribed my name and affixed my notarial seal at King of Prussia, Pennsylvania, on the day and year first above written.



Commonwealth of Pennsylvania - Notary Seal
Teresa Pastella, Notary Public
Montgomery County
My commission expires March 26, 2025
Commission number 1126044
Member, Pennsylvania Association of Notaries

By: Teresa Pastella, Notary Public

This Power of Attorney is made and executed pursuant to and by authority of the following By-laws and Authorizations of The Ohio Casualty Insurance Company, Liberty Mutual Insurance Company, and West American Insurance Company which resolutions are now in full force and effect reading as follows:

ARTICLE IV - OFFICERS: Section 12. Power of Attorney.

Any officer or other official of the Corporation authorized for that purpose in writing by the Chairman or the President, and subject to such limitation as the Chairman or the President may prescribe, shall appoint such attorneys-in-fact, as may be necessary to act in behalf of the Corporation to make, execute, seal, acknowledge and deliver as surety any and all undertakings, bonds, recognizances and other surety obligations. Such attorneys-in-fact, subject to the limitations set forth in their respective powers of attorney, shall have full power to bind the Corporation by their signature and execution of any such instruments and to attach thereto the seal of the Corporation. When so executed, such instruments shall be as binding as if signed by the President and attested to by the Secretary. Any power or authority granted to any representative or attorney-in-fact under the provisions of this article may be revoked at any time by the Board, the Chairman, the President or by the officer or officers granting such power or authority.

ARTICLE XIII - Execution of Contracts: Section 5. Surety Bonds and Undertakings.

Any officer of the Company authorized for that purpose in writing by the chairman or the president, and subject to such limitations as the chairman or the president may prescribe, shall appoint such attorneys-in-fact, as may be necessary to act in behalf of the Company to make, execute, seal, acknowledge and deliver as surety any and all undertakings, bonds, recognizances and other surety obligations. Such attorneys-in-fact subject to the limitations set forth in their respective powers of attorney, shall have full power to bind the Company by their signature and execution of any such instruments and to attach thereto the seal of the Company. When so executed such instruments shall be as binding as if signed by the president and attested by the secretary.

Certificate of Designation - The President of the Company, acting pursuant to the Bylaws of the Company, authorizes David M. Carey, Assistant Secretary to appoint such attorneys-in-fact as may be necessary to act on behalf of the Company to make, execute, seal, acknowledge and deliver as surety any and all undertakings, bonds, recognizances and other surety obligations.

Authorization - By unanimous consent of the Company's Board of Directors, the Company consents that facsimile or mechanically reproduced signature of any assistant secretary of the Company, wherever appearing upon a certified copy of any power of attorney issued by the Company in connection with surety bonds, shall be valid and binding upon the Company with the same force and effect as though manually affixed.

I, Renee C. Llewellyn, the undersigned, Assistant Secretary, The Ohio Casualty Insurance Company, Liberty Mutual Insurance Company, and West American Insurance Company do hereby certify that the original power of attorney of which the foregoing is a full, true and correct copy of the Power of Attorney executed by said Companies, is in full force and effect and has not been revoked.

IN TESTIMONY WHEREOF, I have hereunto set my hand and affixed the seals of said Companies this 1st day of February, 2022.



By: Renee C. Llewellyn, Assistant Secretary

Not valid for mortgage, note, loan, letter of credit, currency rate, interest rate or residual value guarantees.

For bond and/or Power of Attorney (POA) verification inquiries, please call 610-832-8240 or email HOSUR@libertymutual.com.

PAYMENT BOND

KNOW ALL MEN BY THESE PRESENTS That

WHEREAS, the City of San Clemente (hereinafter designated as the "City"), by action taken or a resolution passed _____, 20____ has awarded to O'Connell Engineering & Construction, Inc. hereinafter designated as the "Principal," a contract for the work described as follows:

CAPISTRANO LANE SANITARY SEWER LINE REPAIR, PN 24200 (the "Project"); and

WHEREAS, the work to be performed by the Principal is more particularly set forth in the Contract Documents for the Project dated February 11, 2022 ("Contract Documents"), the terms and conditions of which are expressly incorporated by reference; and

WHEREAS, said Principal is required to furnish a bond in connection with said contract; providing that if said Principal or any of its Subcontractors shall fail to pay for any materials, provisions, provender, equipment, or other supplies used in, upon, for or about the performance of the work contracted to be done, or for any work or labor done thereon of any kind, or for amounts due under the Unemployment Insurance Code or for any amounts required to be deducted, withheld, and paid over to the Employment Development Department from the wages of employees of said Principal and its Subcontractors with respect to such work or labor the Surety on this bond will pay for the same to the extent hereinafter set forth.

NOW THEREFORE, we, the Principal and The Ohio Casualty Insurance Company as Surety, are held and firmly bound unto the City in the penal sum of Forty Six Thousand Seven Hundred and 00/100 Dollars (\$ 46,700.00) lawful money of the United States of America, for the payment of which sum well and truly to be made, we bind ourselves, our heirs, executors, administrators, successors and assigns, jointly and severally, firmly by these presents.

THE CONDITION OF THIS OBLIGATION IS SUCH that if said Principal, his or its subcontractors, heirs, executors, administrators, successors or assigns, shall fail to pay any of the persons named in Section 9100 of the Civil Code, fail to pay for any materials, provisions or other supplies, used in, upon, for or about the performance of the work contracted to be done, or for any work or labor thereon of any kind, or amounts due under the Unemployment Insurance Code with respect to work or labor performed under the contract, or for any amounts required to be deducted, withheld, and paid over to the Employment Development Department or Franchise Tax Board from the wages of employees of the contractor and his subcontractors pursuant to Section 18663 of the Revenue and Taxation Code, with respect to such work and labor the Surety or Sureties will pay for the same, in an amount not exceeding the sum herein above specified.

This bond shall inure to the benefit of any of the persons named in Section 9100 of the Civil Code so as to give a right of action to such persons or their assigns in any suit brought upon this bond.

It is further stipulated and agreed that the Surety on this bond shall not be exonerated or released from the obligation of this bond by any change, extension of time for performance, addition, alteration or modification in, to, or of any contract, plans, specifications, or agreement pertaining or relating to any scheme or work of improvement herein above described, or pertaining or relating to the furnishing of labor, materials, or equipment therefore, nor by any change or modification of any terms of payment or extension of the time for any payment pertaining or relating to any scheme or work of improvement herein above described, nor by any rescission or attempted rescission of the contract, agreement or bond, nor by any conditions precedent or

CALIFORNIA ALL-PURPOSE ACKNOWLEDGMENT

CIVIL CODE 1189

A notary public or other officer completing this certificate verifies only the identity of the individual who signed the document to which this certificate is attached and not the truthfulness, accuracy, or validity of that document.

State of California)

County of Orange)

On 2/1/22 before me, Lisa Pellerito, Notary Public,

personally appeared Vanessa Copeland
Name(s) of Signer(s)

who proved to me on the basis of satisfactory evidence to be the person(s) whose name(s) is/are subscribed to the within instrument and acknowledged to me that he/she/they executed the same in his/her/their authorized capacity(ies), and that by his/her/their signature(s) on the instrument the person(s), or the entity upon behalf of which the person(s) acted, executed the instrument.

I certify under PENALTY OF PERJURY under the laws of the State of California that the foregoing paragraph is true and correct.

WITNESS my hand and official seal.

Signature: Lisa Pellerito
Signature of Notary Public

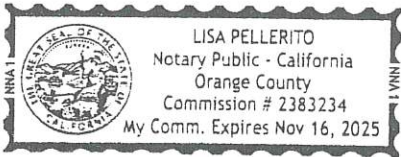

Place Notary Seal Above

OPTIONAL

Though the information below is not required by law, it may prove valuable to persons relying on the document and could present fraudulent and reattachment of this form to another document.

Description of Attached Document

Type or Title of Document:

Document Date: Number of Pages:

Signer(s) Other Than Named Above:

Capacity(ies) Claimed by Signer(s)

Signer's Name: Vanessa Copeland

- Individual
Corporate Officer - Title(s):
Partner: Limited General
Attorney in Fact
Trustee
Guardian or Conservator
Other:

Signer Is Representing:

Capacity(ies) Claimed by Signer(s)

Signer's Name:

- Individual
Corporate Officer - Title(s):
Partner: Limited General
Attorney in Fact
Trustee
Guardian or Conservator
Other:

Signer Is Representing:



This Power of Attorney limits the acts of those named herein, and they have no authority to bind the Company except in the manner and to the extent herein stated.

Liberty Mutual Insurance Company
The Ohio Casualty Insurance Company
West American Insurance Company

Certificate No: 8206873-971958

POWER OF ATTORNEY

KNOWN ALL PERSONS BY THESE PRESENTS: That The Ohio Casualty Insurance Company is a corporation duly organized under the laws of the State of New Hampshire, that Liberty Mutual Insurance Company is a corporation duly organized under the laws of the State of Massachusetts, and West American Insurance Company is a corporation duly organized under the laws of the State of Indiana (herein collectively called the "Companies"), pursuant to and by authority herein set forth, does hereby name, constitute and appoint, Eric Lowey, Kevin Cathcart, Lisa Pellerito, Mark Richardson, Natassia Kirk-Smith, Terah Lane, Vanessa Copeland

all of the city of Costa Mesa state of CA each individually if there be more than one named, its true and lawful attorney-in-fact to make, execute, seal, acknowledge and deliver, for and on its behalf as surety and as its act and deed, any and all undertakings, bonds, recognizances and other surety obligations, in pursuance of these presents and shall be as binding upon the Companies as if they have been duly signed by the president and attested by the secretary of the Companies in their own proper persons.

IN WITNESS WHEREOF, this Power of Attorney has been subscribed by an authorized officer or official of the Companies and the corporate seals of the Companies have been affixed thereto this 2nd day of December, 2021.



Liberty Mutual Insurance Company
The Ohio Casualty Insurance Company
West American Insurance Company

By: David M. Carey, Assistant Secretary

Not valid for mortgage, note, loan, letter of credit, currency rate, interest rate or residual value guarantees.

State of PENNSYLVANIA
County of MONTGOMERY ss

On this 2nd day of December, 2021 before me personally appeared David M. Carey, who acknowledged himself to be the Assistant Secretary of Liberty Mutual Insurance Company, The Ohio Casualty Company, and West American Insurance Company, and that he, as such, being authorized so to do, execute the foregoing instrument for the purposes therein contained by signing on behalf of the corporations by himself as a duly authorized officer.

IN WITNESS WHEREOF, I have hereunto subscribed my name and affixed my notarial seal at King of Prussia, Pennsylvania, on the day and year first above written.



Commonwealth of Pennsylvania - Notary Seal
Teresa Pastella, Notary Public
Montgomery County
My commission expires March 26, 2025
Commission number 1126044
Member, Pennsylvania Association of Notaries

By: Teresa Pastella, Notary Public

This Power of Attorney is made and executed pursuant to and by authority of the following By-laws and Authorizations of The Ohio Casualty Insurance Company, Liberty Mutual Insurance Company, and West American Insurance Company which resolutions are now in full force and effect reading as follows:

ARTICLE IV - OFFICERS: Section 12. Power of Attorney.

Any officer or other official of the Corporation authorized for that purpose in writing by the Chairman or the President, and subject to such limitation as the Chairman or the President may prescribe, shall appoint such attorneys-in-fact, as may be necessary to act in behalf of the Corporation to make, execute, seal, acknowledge and deliver as surety any and all undertakings, bonds, recognizances and other surety obligations. Such attorneys-in-fact, subject to the limitations set forth in their respective powers of attorney, shall have full power to bind the Corporation by their signature and execution of any such instruments and to attach thereto the seal of the Corporation. When so executed, such instruments shall be as binding as if signed by the President and attested to by the Secretary. Any power or authority granted to any representative or attorney-in-fact under the provisions of this article may be revoked at any time by the Board, the Chairman, the President or by the officer or officers granting such power or authority.

ARTICLE XIII - Execution of Contracts: Section 5. Surety Bonds and Undertakings.

Any officer of the Company authorized for that purpose in writing by the chairman or the president, and subject to such limitations as the chairman or the president may prescribe, shall appoint such attorneys-in-fact, as may be necessary to act in behalf of the Company to make, execute, seal, acknowledge and deliver as surety any and all undertakings, bonds, recognizances and other surety obligations. Such attorneys-in-fact subject to the limitations set forth in their respective powers of attorney, shall have full power to bind the Company by their signature and execution of any such instruments and to attach thereto the seal of the Company. When so executed such instruments shall be as binding as if signed by the president and attested by the secretary.

Certificate of Designation -- The President of the Company, acting pursuant to the Bylaws of the Company, authorizes David M. Carey, Assistant Secretary to appoint such attorneys-in-fact as may be necessary to act on behalf of the Company to make, execute, seal, acknowledge and deliver as surety any and all undertakings, bonds, recognizances and other surety obligations.

Authorization -- By unanimous consent of the Company's Board of Directors, the Company consents that facsimile or mechanically reproduced signature of any assistant secretary of the Company, wherever appearing upon a certified copy of any power of attorney issued by the Company in connection with surety bonds, shall be valid and binding upon the Company with the same force and effect as though manually affixed.

I, Renee C. Llewellyn, the undersigned, Assistant Secretary, The Ohio Casualty Insurance Company, Liberty Mutual Insurance Company, and West American Insurance Company do hereby certify that the original power of attorney of which the foregoing is a full, true and correct copy of the Power of Attorney executed by said Companies, is in full force and effect and has not been revoked.

IN TESTIMONY WHEREOF, I have hereunto set my hand and affixed the seals of said Companies this 1st day of February, 2022.



By: Renee C. Llewellyn, Assistant Secretary

For bond and/or Power of Attorney (POA) verification inquiries, please call 610-832-8240 or email HOSUR@libertymutual.com.

EXHIBIT "G"
FEDERAL REQUIREMENTS

N/A

EXHIBIT "H"

INSURANCE REQUIREMENTS

3.13 Insurance.

3.13.1 Time for Compliance. Contractor shall not commence work under this Contract until it has provided evidence satisfactory to the City that it has secured all insurance required under this section. In addition, Contractor shall not allow any subcontractor to commence work on any subcontract as required in section 1.1.12 of this agreement.

3.13.2 Types of Insurance Required. As a condition precedent to the effectiveness of this Contract for work to be performed hereunder, and without limiting the indemnity provisions of the Contract, the Contractor, in partial performance of its obligations under such Contract, shall procure and maintain in full force and effect during the term of the Contract the following policies of insurance. If the existing policies do not meet the insurance requirements set forth herein, Contractor agrees to amend, supplement or endorse the policies to do so.

(A) Commercial General Liability: Commercial General Liability Insurance which affords coverage at least as broad as Insurance Services Office "occurrence" form CG 0001, or the exact equivalent, and shall be no less than \$1,000,000 per occurrence and no less than \$2,000,000 in the general aggregate. Defense costs shall be paid in addition to the limits. The policy shall contain no endorsements or provisions limiting coverage for (1) contractual liability; (2) cross liability exclusion for claims or suits by one insured against another; or (3) contain any other exclusion contrary to the Contract.

(B) Automobile Liability Insurance: Automobile Liability Insurance with coverage at least as broad as Insurance Services Office Form CA 0001 covering "Any Auto" (Symbol 1), or the exact equivalent, covering bodily injury and property damage for all activities shall be in an amount of not less than \$1,000,000 combined limit for each occurrence.

(C) Workers' Compensation: Workers' Compensation Insurance, as required by the State of California and Employer's Liability Insurance with a limit of not less than \$1,000,000 per accident for bodily injury and disease.

(D) Not Used.

(E) Contractors Pollution Liability: Not used.

3.13.3 Endorsements. Required insurance policies shall contain the following provisions, or Contractor shall provide endorsements on forms approved by the City to add the following provisions to the insurance policies:

(A) Commercial General Liability

(1) Additional Insured: The City, its officials, officers, employees, agents, and volunteers shall be additional insureds with regard to liability and defense of suits or claims arising out of the performance of the Contract.

all endorsements affecting each policy. Required insurance policies shall not be in compliance if they include any limiting provision or endorsement that has not been submitted to the City for approval. The certificates and endorsements for each insurance policy shall be signed by a person authorized by that insurer to bind coverage on its behalf. At least fifteen (15 days) prior to the expiration of any such policy, evidence of insurance showing that such insurance coverage has been renewed or extended shall be filed with the City. If such coverage is cancelled or reduced, and not replaced immediately so as to avoid a lapse in the required coverage, Contractor shall, within ten (10) days after receipt of written notice of such cancellation or reduction of coverage, file with the City evidence of insurance showing that the required insurance has been reinstated or has been provided through another insurance company or companies.

3.13.8 Failure to Maintain Coverage. In the event any policy of insurance required under this Contract does not comply with these specifications or is canceled and not replaced immediately so as to avoid a lapse in the required coverage, City has the right but not the duty to obtain the insurance it deems necessary and any premium paid by City will be promptly reimbursed by Contractor or City will withhold amounts sufficient to pay premium from Contractor payments. In the alternative, City may cancel this Contract, effective upon notice.

3.13.9 Acceptability of Insurers. Each such policy shall be from a company or companies with a current A.M. Best's rating of no less than A- VII and authorized to transact business of insurance in the State of California, or otherwise allowed to place insurance through surplus line brokers under applicable provisions of the California Insurance Code or any federal law.

3.13.10 Enforcement of Contract Provisions (non estoppel). Contractor acknowledges and agrees that actual or alleged failure on the part of the City to inform Contractor of non-compliance with any requirement imposes no additional obligation on the City nor does it waive any rights hereunder.

3.13.11 Requirements Not Limiting. Requirement of specific coverage or minimum limits contained in this Appendix are not intended as a limitation on coverage, limits, or other requirement, or a waiver of any coverage normally provided by any insurance.

3.13.12 Insurance for Subcontractors. Contractor shall include all Subcontractors as additional insureds under the Contractor's policies, or the Contractor shall be responsible for causing Subcontractors to purchase the appropriate insurance in compliance with the terms of these Insurance Requirements, including adding the City, its officials, officers, employees, agents and volunteers as additional insureds to the Subcontractor's policies. All policies of Commercial General Liability insurance provided by Subcontractors shall be endorsed to name the City, its officials, officers, employees, agents and volunteers as additional insureds using endorsement form ISO CG 20 38 04 13. Contractor shall not allow any Subcontractor to commence work until it has received satisfactory evidence of Subcontractor's compliance with all insurance requirements under this Contract, to the extent applicable. The Contractor shall provide satisfactory evidence of compliance with this section upon request of the City.

O'Connell Engineering & Construction

36572 Deauville Rd.

Winchester, CA 92596-9012

Phone: 951-623-6034

Fax: 951-790-0122

Request for Proposal

No.

1

TITLE: Capistrano Lane SS Line
Repair

DATE: 01/06/22

Project:

JOB:

TO: Attn: Augusto Chamorro
City of San Clemente
910 Calle Negocio, Suite 100
San Clemente, CA 92673

CONTRACT NO:

RE:

To:

From:

Number:

DESCRIPTION OF PROPOSAL

Per the City of San Clemente's request, O'Connell Engineering and Construction has prepared a proposal for the Capistrano Lane S. S. Line Repair PN 24200.

1. Remove 15 L.F. +/- of existing 8" V.C.P. sanitary sewer pipe and Replace with 8" P.V.C. SDR 26 pipe and Reconnect existing 4" sewer lateral) per Exhibit B and City Standards. This is a Lump Sum construction item. Removal and proper disposal of removed materials and trenching and trench restoration, including AC and CMB used for structural section, are included in bid item.
2. Dewatering as directed by the Engineer. This is a Lump Sum construction item.
3. Over-excavation of unsuitable material (Up to 3 ft.) at the trench bottom and replace with C.M.B. as directed by the Engineer. This construction item will be paid per cubic yard (Approximately 10 C.Y.) Removal and proper disposal of unsuitable material included in bid item.

Our cost covers all bonding, labor, material, and equipment to complete this project.

Item	Description	Stock#	Quantity	Units	Unit Price	Tax Rate	Net Amount
001	Bid Item 1		1	LS	\$37,700.00		\$37,700.00
002	Bid Item 2		1	LS	\$6,000.00		\$6,000.00
003	Bid Item 3		10	CY	\$300.00		\$3,000.00

Unit Cost: \$46,700.00

Unit Tax: \$0.00

Total: \$46,700.00

APPROVAL:

By: *Rhonda O'Connell*
Rhonda O'Connell

By: _____

Date: 01/06/22

Date: _____

CERTIFICATE OF LIABILITY INSURANCE

THIS CERTIFICATE IS ISSUED AS A MATTER OF INFORMATION ONLY AND CONFERS NO RIGHTS UPON THE CERTIFICATE HOLDER. THIS CERTIFICATE DOES NOT AFFIRMATIVELY OR NEGATIVELY AMEND, EXTEND OR ALTER THE COVERAGE AFFORDED BY THE POLICIES BELOW. THIS CERTIFICATE OF INSURANCE DOES NOT CONSTITUTE A CONTRACT BETWEEN THE ISSUING INSURER(S), AUTHORIZED REPRESENTATIVE OR PRODUCER, AND THE CERTIFICATE HOLDER.

IMPORTANT: If the certificate holder is an ADDITIONAL INSURED, the policy(ies) must have ADDITIONAL INSURED provisions or be endorsed. If SUBROGATION IS WAIVED, subject to the terms and conditions of the policy, certain policies may require an endorsement. A statement on this certificate does not confer any rights to the certificate holder in lieu of such endorsement(s).

PRODUCER: Marsh & McLennan Agency LLC, Marsh & McLennan Ins. Agency LLC, 1 Polaris Way #300, Aliso Viejo, CA 92656. CONTACT NAME: Simson Soetanto, PHONE: 800 321-4696, FAX: 858-452-7530, E-MAIL ADDRESS: Simson.Soetanto@marshmma.com. INSURER(S) AFFORDING COVERAGE: EVANSTON INSURANCE COMPANY (35378), STATE COMPENSATION INS FUND OF CA (35076), OHIO SECURITY INSURANCE COMPANY (24082).

COVERAGES CERTIFICATE NUMBER: REVISION NUMBER:

THIS IS TO CERTIFY THAT THE POLICIES OF INSURANCE LISTED BELOW HAVE BEEN ISSUED TO THE INSURED NAMED ABOVE FOR THE POLICY PERIOD INDICATED. NOTWITHSTANDING ANY REQUIREMENT, TERM OR CONDITION OF ANY CONTRACT OR OTHER DOCUMENT WITH RESPECT TO WHICH THIS CERTIFICATE MAY BE ISSUED OR MAY PERTAIN, THE INSURANCE AFFORDED BY THE POLICIES DESCRIBED HEREIN IS SUBJECT TO ALL THE TERMS, EXCLUSIONS AND CONDITIONS OF SUCH POLICIES. LIMITS SHOWN MAY HAVE BEEN REDUCED BY PAID CLAIMS.

Table with columns: INSR LTR, TYPE OF INSURANCE, ADDL SUBR INSR, POLICY NUMBER, POLICY EFF (MM/DD/YYYY), POLICY EXP (MM/DD/YYYY), LIMITS. Rows include Commercial General Liability, Automobile Liability, Umbrella Liability, and Workers Compensation and Employers' Liability.

DESCRIPTION OF OPERATIONS / LOCATIONS / VEHICLES (ACORD 101, Additional Remarks Schedule, may be attached if more space is required) General Liability: Per Project Cap - \$10,000,000

RE:CAPISTRANO LANE SANITARY SEWER LINE REPAIR IN THE CITY OF SAN CLEMENTE. PN 24200 (See Attached Descriptions)

CERTIFICATE HOLDER: City of San Clemente, 910 Calle Negocio, Ste. 300, San Clemente, CA 92673. CANCELLATION: SHOULD ANY OF THE ABOVE DESCRIBED POLICIES BE CANCELLED BEFORE THE EXPIRATION DATE THEREOF, NOTICE WILL BE DELIVERED IN ACCORDANCE WITH THE POLICY PROVISIONS. AUTHORIZED REPRESENTATIVE: [Signature]

DESCRIPTIONS (Continued from Page 1)

The City, its officials, officers, employees, agents, and volunteers are included as additional insured as respects to General Liability and Auto Liability per attached endorsements. Primary and Non-Contributory Wording applies per attached endorsement. Waiver of Subrogation applies to General Liability, Auto Liability and Workers Compensation per attached endorsements.

THIS ENDORSEMENT CHANGES THE POLICY. PLEASE READ IT CAREFULLY.

**ADDITIONAL INSURED – OWNERS, LESSEES OR
CONTRACTORS – SCHEDULED PERSON OR
ORGANIZATION**

This endorsement modifies insurance provided under the following:

COMMERCIAL GENERAL LIABILITY COVERAGE PART

SCHEDULE

Name Of Additional Insured Person(s) Or Organization(s):	Location(s) Of Covered Operations
As required by written contract executed by both parties prior to loss	All locations

Information required to complete this Schedule, if not shown above, will be shown in the Declarations.

A. Section II – Who Is An Insured is amended to include as an additional insured the person(s) or organization(s) shown in the Schedule, but only with respect to liability for "bodily injury", "property damage" or "personal and advertising injury" caused, in whole or in part, by:

1. Your acts or omissions; or
2. The acts or omissions of those acting on your behalf;

in the performance of your ongoing operations for the additional insured(s) at the location(s) designated above.

B. With respect to the insurance afforded to these additional insureds, the following additional exclusions apply:

This insurance does not apply to "bodily injury" or "property damage" occurring after:

1. All work, including materials, parts or equipment furnished in connection with such work, on the project (other than service, maintenance or repairs) to be performed by or on behalf of the additional insured(s) at the location of the covered operations has been completed; or
2. That portion of "your work" out of which the injury or damage arises has been put to its intended use by any person or organization other than another contractor or subcontractor engaged in performing operations for a principal as a part of the same project.

INSURED: O'Connell Engineering&Construction, Inc

POLICY#: MKLV5PBC003194

POLICY PERIOD: 05/08/2021

TO: 05/08/2022

COMMERCIAL GENERAL LIABILITY
CG 20 37 07 04

THIS ENDORSEMENT CHANGES THE POLICY. PLEASE READ IT CAREFULLY.

ADDITIONAL INSURED – OWNERS, LESSEES OR CONTRACTORS – COMPLETED OPERATIONS

This endorsement modifies insurance provided under the following:

COMMERCIAL GENERAL LIABILITY COVERAGE PART

SCHEDULE

Name Of Additional Insured Person(s) Or Organization(s):	Location And Description Of Completed Operations
As required by written contract executed by both parties prior to loss	All locations
Information required to complete this Schedule, if not shown above, will be shown in the Declarations.	

Section II – Who Is An Insured is amended to include as an additional insured the person(s) or organization(s) shown in the Schedule, but only with respect to liability for "bodily injury" or "property damage" caused, in whole or in part, by "your work" at the location designated and described in the schedule of this endorsement performed for that additional insured and included in the "products-completed operations hazard".

WAIVER OF TRANSFER OF RIGHTS OF RECOVERY AGAINST OTHERS TO US

This endorsement modifies insurance provided under the following:

COMMERCIAL GENERAL LIABILITY COVERAGE PART
PRODUCTS/COMPLETED OPERATIONS LIABILITY COVERAGE PART

SCHEDULE

<p>Name Of Person Or Organization: All persons or organizations as requested by written contract with the Named Insured.</p>
<p>Information required to complete this Schedule, if not shown above, will be shown in the Declarations.</p>

The following is added to Paragraph 8. **Transfer Of Rights Of Recovery Against Others To Us of Section IV – Conditions:**

We waive any right of recovery we may have against the person or organization shown in the Schedule above because of payments we make for injury or damage arising out of your ongoing operations or "your work" done under a contract with that person or organization and included in the "products-completed operations hazard". This waiver applies only to the person or organization shown in the Schedule above.

INSURED: O'Connell Engineering&Construction, Inc

POLICY#: MKLV5PBC003194

POLICY PERIOD: 05/08/2021

TO: 05/08/2022

THIS ENDORSEMENT CHANGES THE POLICY. PLEASE READ IT CAREFULLY.

**PRIMARY AND NONCONTRIBUTORY –
OTHER INSURANCE CONDITION**

This endorsement modifies insurance provided under the following:

COMMERCIAL GENERAL LIABILITY COVERAGE PART
PRODUCTS/COMPLETED OPERATIONS LIABILITY COVERAGE PART

The following is added to the **Other Insurance** Condition and supersedes any provision to the contrary:

Primary And Noncontributory Insurance

This insurance is primary to and will not seek contribution from any other insurance available to an additional insured under your policy provided that:

(1) The additional insured is a Named Insured under such other insurance; and

(2) You have agreed in writing in a contract or agreement that this insurance would be primary and would not seek contribution from any other insurance available to the additional insured.

THIS ENDORSEMENT CHANGES THE POLICY. PLEASE READ IT CAREFULLY.

CALIFORNIA BUSINESS AUTO COVERAGE ENHANCEMENT ENDORSEMENT

This endorsement modifies insurance provided under the following:

BUSINESS AUTO COVERAGE FORM

With respect to coverage afforded by this endorsement, the provisions of the policy apply unless modified by the endorsement.

If the policy to which this endorsement is attached also contains a Business Auto Coverage Enhancement Endorsement with a specific state named in the title, this endorsement does not apply to vehicles garaged in that specified state.

COVERAGE INDEX

<u>SUBJECT</u>	<u>PROVISION NUMBER</u>
ACCIDENTAL AIRBAG DEPLOYMENT	12
ADDITIONAL INSURED BY CONTRACT, AGREEMENT OR PERMIT	3
AMENDED DUTIES IN THE EVENT OF ACCIDENT, CLAIM, SUIT OR LOSS	20
AMENDED FELLOW EMPLOYEE EXCLUSION	5
AUDIO, VISUAL AND DATA ELECTRONIC EQUIPMENT COVERAGE	14
BODILY INJURY REDEFINED	24
EMPLOYEES AS INSUREDS (Including Employee Hired Auto)	2
EXTRA EXPENSE - BROADENED COVERAGE	10
GLASS REPAIR - WAIVER OF DEDUCTIBLE	16
HIRED AUTO COVERAGE TERRITORY	22
HIRED AUTO PHYSICAL DAMAGE (Including Employee Hired Auto)	6
LOAN / LEASE GAP (Coverage Not Available In New York)	15
NEWLY FORMED OR ACQUIRED SUBSIDIARIES	1
PARKED AUTO COLLISION COVERAGE (WAIVER OF DEDUCTIBLE)	17
PERSONAL EFFECTS COVERAGE	11
PHYSICAL DAMAGE - ADDITIONAL TRANSPORTATION EXPENSE COVERAGE	8
PHYSICAL DAMAGE DEDUCTIBLE - VEHICLE TRACKING SYSTEM	13
PRIMARY AND NON-CONTRIBUTORY - WRITTEN CONTRACT OR WRITTEN AGREEMENT	23
RENTAL REIMBURSEMENT	9
SUPPLEMENTARY PAYMENTS	4
TOWING AND LABOR	7
TWO OR MORE DEDUCTIBLES	18
UNINTENTIONAL FAILURE TO DISCLOSE HAZARDS	19
WAIVER OF TRANSFER OF RIGHTS OF RECOVERY AGAINST OTHERS TO US	21

SECTION II - LIABILITY COVERAGE is amended as follows:

1. NEWLY FORMED OR ACQUIRED SUBSIDIARIES

SECTION II - LIABILITY COVERAGE, Paragraph A.1. **Who Is An Insured** is amended to include the following as an "insured":

d. Any legally incorporated subsidiary of which you own more than 50 percent interest during the policy period. Coverage is afforded only for 90 days from the date of acquisition or formation. However, "insured" does not include any organization that:

- (1) Is a partnership or joint venture; or
- (2) Is an "insured" under any other automobile policy except a policy written specifically to apply in excess of this policy; or
- (3) Has exhausted its Limit of Insurance or had its policy terminated under any other automobile policy.

Coverage under this provision d. does not apply to "bodily injury" or "property damage" that occurred before you acquired or formed the organization.

2. EMPLOYEES AS INSURED

SECTION II - LIABILITY COVERAGE, Paragraph A.1. **Who Is An Insured** is amended to include the following as an "insured":

- e. Any "employee" of yours while using a covered "auto" you do not own, hire or borrow but only for acts within the scope of their employment by you. Insurance provided by this endorsement is excess over any other insurance available to any "employee".
- f. Any "employee" of yours while operating an "auto" hired or borrowed under a written contract or agreement in that "employee's" name, with your permission, while performing duties related to the conduct of your business and within the scope of their employment. Insurance provided by this endorsement is excess over any other insurance available to the "employee".

3. ADDITIONAL INSURED BY CONTRACT, AGREEMENT OR PERMIT

SECTION II - LIABILITY COVERAGE, Paragraph A.1. **Who Is An Insured** is amended to include the following as an "insured":

- g. Any person or organization with respect to the operation, maintenance or use of a covered "auto", provided that you and such person or organization have agreed in a written contract, written agreement, or permit issued to you by governmental or public authority, to add such person, or organization, or governmental or public authority to this policy as an "insured".

However, such person or organization is an "insured";

- (1) Only with respect to the operation, maintenance or use of a covered "auto";
- (2) Only for "bodily injury" or "property damage" caused by an "accident" which takes place after you executed the written contract or written agreement, or the permit has been issued to you; and
- (3) Only for the duration of that contract, agreement or permit.

The "insured" is required to submit a claim to any other insurer to which coverage could apply for defense and indemnity. Unless the "insured" has agreed in writing to primary noncontributory wording per enhancement number 24, this policy is excess over any other collectible insurance.

4. SUPPLEMENTARY PAYMENTS

SECTION II - LIABILITY COVERAGE, Coverage Extensions, 2.a. **Supplementary Payments**, Paragraphs (2) and (4) are replaced by the following:

- (2) Up to \$3,000 for cost of bail bonds (including bonds for related traffic violations) required because of an "accident" we cover. We do not have to furnish these bonds.
- (4) All reasonable expenses incurred by the "insured" at our request, including actual loss of earnings up to \$500 a day because of time off from work.

5. AMENDED FELLOW EMPLOYEE EXCLUSION

In those jurisdictions where, by law, fellow "employees" are not entitled to the protection afforded to the employer by the workers compensation exclusivity rule, or similar protection, the following provision is added:

SECTION II - LIABILITY, Exclusion B.5. **Fellow Employee** does not apply if the "bodily injury" results from the use of a covered "auto" you own or hire if you have workers compensation insurance in force for all of your "employees" at the time of "loss".

This coverage is excess over any other collectible insurance.

SECTION III - PHYSICAL DAMAGE COVERAGE is amended as follows:

6. HIRED AUTO PHYSICAL DAMAGE

Paragraph A.4. **Coverage Extensions** of **SECTION III - PHYSICAL DAMAGE COVERAGE**, is amended by adding the following:

If hired "autos" are covered "autos" for Liability Coverage, and if Comprehensive, Specified Causes of Loss or Collision coverage are provided under the Business Auto Coverage Form for any "auto" you own, then the Physical Damage coverages provided are extended to "autos":

- a. You hire, rent or borrow; or
- b. Your "employee" hires or rents under a written contract or agreement in that "employee's" name, but only if the damage occurs while the vehicle is being used in the conduct of your business, subject to the following limit and deductible:
 - a. The most we will pay for "loss" in any one "accident" or "loss" is the smallest of:
 - (1) \$50,000; or
 - (2) The actual cash value of the damaged or stolen property as of the time of the "loss"; or
 - (3) The cost of repairing or replacing the damaged or stolen property with other property of like kind and quality, minus a deductible.
 - b. The deductible will be equal to the largest deductible applicable to any owned "auto" for that coverage.
 - c. Subject to the limit, deductible and excess provisions described in this provision, we will provide coverage equal to the broadest coverage applicable to any covered "auto" you own.
 - d. Subject to a maximum of \$1,000 per "accident", we will also cover the actual loss of use of the hired "auto" if it results from an "accident", you are legally liable and the lessor incurs an actual financial loss.
 - e. This coverage extension does not apply to:
 - (1) Any "auto" that is hired, rented or borrowed with a driver; or
 - (2) Any "auto" that is hired, rented or borrowed from your "employee" or any member of your "employee's" household.

Coverage provided under this extension is excess over any other collectible insurance available at the time of "loss".

7. TOWING AND LABOR

SECTION III - PHYSICAL DAMAGE COVERAGE, Paragraph A.2. Towing, is amended by the addition of the following:

We will pay towing and labor costs incurred, up to the limits shown below, each time a covered "auto" classified and rated as a private passenger type, "light truck" or "medium truck" is disabled:

- a. For private passenger type vehicles, we will pay up to \$75 per disablement.
- b. For "light trucks", we will pay up to \$75 per disablement. "Light trucks" are trucks that have a gross vehicle weight (GVW) of 10,000 pounds or less.
- c. For "medium trucks", we will pay up to \$150 per disablement. "Medium trucks" are trucks that have a gross vehicle weight (GVW) of 10,001 - 20,000 pounds.

However, the labor must be performed at the place of disablement.

8. PHYSICAL DAMAGE - ADDITIONAL TRANSPORTATION EXPENSE COVERAGE

Paragraph **A.4.a. Coverage Extensions, Transportation Expenses of SECTION III - PHYSICAL DAMAGE COVERAGE**, is amended to provide a limit of \$50 per day and a maximum limit of \$1,500.

9. RENTAL REIMBURSEMENT

SECTION III - PHYSICAL DAMAGE COVERAGE, A. Coverage, is amended by adding the following:

- a. We will pay up to \$75 per day for rental reimbursement expenses incurred by you for the rental of an "auto" because of "accident" or "loss", to an "auto" for which we also pay a "loss" under Comprehensive, Specified Causes of Loss or Collision Coverages. We will pay only for those expenses incurred after the first 24 hours following the "accident" or "loss" to the covered "auto."
- b. Rental Reimbursement requires the rental of a comparable or lesser vehicle, which in many cases may be substantially less than \$75 per day, and will only be allowed for the period of time it should take to repair or replace the vehicle with reasonable speed and similar quality, up to a maximum of 30 days.
- c. We will also pay up to \$500 for reasonable and necessary expenses incurred by you to remove and replace your tools and equipment from the covered "auto". This limit is excess over any other collectible insurance.

- d. This coverage does not apply unless you have a business necessity that other "autos" available for your use and operation cannot fill.
- e. If "loss" results from the total theft of a covered "auto" of the private passenger type, we will pay under this coverage only that amount of your rental reimbursement expenses which is not already provided under Paragraph 4. Coverage Extension.
- f. No deductible applies to this coverage.
- g. The insurance provided under this extension is excess over any other collectible insurance.

If this policy also provides Rental Reimbursement Coverage you purchased, the coverage provided by this Enhancement Endorsement is in addition to the coverage you purchased.

For the purposes of this endorsement provision, materials and equipment do not include "personal effects" as defined in provision 11.B.

10. EXTRA EXPENSE - BROADENED COVERAGE

Under SECTION III - PHYSICAL DAMAGE COVERAGE, A. Coverage, we will pay for the expense of returning a stolen covered "auto" to you. The maximum amount we will pay is \$1,000.

11. PERSONAL EFFECTS COVERAGE

A. SECTION III - PHYSICAL DAMAGE COVERAGE, A. Coverage, is amended by adding the following:

If you have purchased Comprehensive Coverage on this policy for an "auto" you own and that "auto" is stolen, we will pay, without application of a deductible, up to \$600 for "personal effects" stolen with the "auto."

The insurance provided under this provision is excess over any other collectible insurance.

B. SECTION V - DEFINITIONS is amended by adding the following:

For the purposes of this provision, "personal effects" mean tangible property that is worn or carried by an "insured." "Personal effects" does not include tools, equipment, jewelry, money or securities.

12. ACCIDENTAL AIRBAG DEPLOYMENT

SECTION III - PHYSICAL DAMAGE COVERAGE, B. Exclusions is amended by adding the following:

If you have purchased Comprehensive or Collision Coverage under this policy, the exclusion for "loss" relating to mechanical breakdown does not apply to the accidental discharge of an airbag.

Any insurance we provide shall be excess over any other collectible insurance or reimbursement by manufacturer's warranty. However, we agree to pay any deductible applicable to the other coverage or warranty.

13. PHYSICAL DAMAGE DEDUCTIBLE - VEHICLE TRACKING SYSTEM

SECTION III - PHYSICAL DAMAGE COVERAGE, D. Deductible, is amended by adding the following:

Any Comprehensive Deductible shown in the Declarations will be reduced by 50% for any "loss" caused by theft if the vehicle is equipped with a vehicle tracking device such as a radio tracking device or a global position device and that device was the method of recovery of the vehicle.

14. AUDIO, VISUAL AND DATA ELECTRONIC EQUIPMENT COVERAGE

SECTION III - PHYSICAL DAMAGE COVERAGE, B. Exclusions, Paragraph a. of the exception to exclusions 4.c. and 4.d. is deleted and replaced with the following:

Exclusions 4.c. and 4.d. do not apply to:

- a. Electronic equipment that receives or transmits audio, visual or data signals, whether or not designed solely for the reproduction of sound, if the equipment is:
 - (1) Permanently installed in the covered "auto" at the time of the "loss" or removable from a housing unit that is permanently installed in the covered "auto"; and
 - (2) Designed to be solely operated by use from the power from the "auto's" electrical system; and
 - (3) Physical damage coverages are provided for the covered "auto".

If the "loss" occurs solely to audio, visual or data electronic equipment or accessories used with this equipment, then our obligation to pay for, repair, return or replace damaged or stolen property will be reduced by a \$100 deductible.

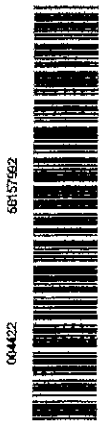

15. LOAN / LEASE GAP COVERAGE (Not Applicable In New York)

A. Paragraph C. Limit Of Insurance of SECTION III - PHYSICAL DAMAGE COVERAGE is amended by adding the following:

The most we will pay for a "total loss" to a covered "auto" owned by or leased to you in any one "accident" is the greater of the:

1. Balance due under the terms of the loan or lease to which the damaged covered "auto" is subject at the time of the "loss" less the amount of:
 - a. Overdue payments and financial penalties associated with those payments as of the date of the "loss";
 - b. Financial penalties imposed under a lease due to high mileage, excessive use or abnormal wear and tear;
 - c. Costs for extended warranties, Credit Life Insurance, Health, Accident or Disability Insurance purchased with the loan or lease;
 - d. Transfer or rollover balances from previous loans or leases;
 - e. Final payment due under a "Balloon Loan";
 - f. The dollar amount of any unrepaired damage which occurred prior to the "total loss" of a covered "auto";
 - g. Security deposits not refunded by a lessor;
 - h. All refunds payable or paid to you as a result of the early termination of a lease agreement or as a result of the early termination of any warranty or extended service agreement on a covered "auto";
 - i. Any amount representing taxes;
 - j. Loan or lease termination fees; or
2. The actual cash value of the damage or stolen property as of the time of the "loss".

An adjustment for depreciation and physical condition will be made in determining the actual cash value at the time of the "loss". This adjustment is not applicable in Texas.

B. Additional Conditions

This coverage applies only to the original loan for which the covered "auto" that incurred the "loss" serves as collateral, or lease written on the covered "auto" that incurred the "loss".

C. SECTION V - DEFINITIONS is changed by adding the following:

As used in this endorsement provision, the following definitions apply:

"Total loss" means a "loss" in which the cost of repairs plus the salvage value exceeds the actual cash value.

A "balloon loan" is one with periodic payments that are insufficient to repay the balance over the term of the loan, thereby requiring a large final payment.

16. GLASS REPAIR - WAIVER OF DEDUCTIBLE

Paragraph **D. Deductible** of **SECTION III - PHYSICAL DAMAGE COVERAGE** is amended by the addition of the following:

No deductible applies to glass damage if the glass is repaired rather than replaced.

17. PARKED AUTO COLLISION COVERAGE (WAIVER OF DEDUCTIBLE)

Paragraph **D. Deductible** of **SECTION III - PHYSICAL DAMAGE COVERAGE** is amended by the addition of the following:

The deductible does not apply to "loss" caused by collision to such covered "auto" of the private passenger type or light weight truck with a gross vehicle weight of 10,000 lbs. or less as defined by the manufacturer as maximum loaded weight the "auto" is designed to carry while it is:

- a. In the charge of an "Insured";
- b. Legally parked; and
- c. Unoccupied.

The "loss" must be reported to the police authorities within 24 hours of known damage.

The total amount of the damage to the covered "auto" must exceed the deductible shown in the Declarations.

This provision does not apply to any "loss" if the covered "auto" is in the charge of any person or organization engaged in the automobile business.

18. TWO OR MORE DEDUCTIBLES

Under **SECTION III - PHYSICAL DAMAGE COVERAGE**, if two or more company policies or coverage forms apply to the same "accident", the following applies to Paragraph **D. Deductible** :

- a. If the applicable Business Auto deductible is the smaller (or smallest) deductible, it will be waived; or
- b. If the applicable Business Auto deductible is not the smaller (or smallest) deductible, it will be reduced by the amount of the smaller (or smallest) deductible; or
- c. If the "loss" involves two or more Business Auto coverage forms or policies, the smaller (or smallest) deductible will be waived.

For the purpose of this endorsement, company means any company that is part of the Liberty Mutual Group.

SECTION IV - BUSINESS AUTO CONDITIONS is amended as follows:

19. UNINTENTIONAL FAILURE TO DISCLOSE HAZARDS

SECTION IV- BUSINESS AUTO CONDITIONS, Paragraph **B.2.** is amended by adding the following:

If you unintentionally fail to disclose any hazards, exposures or material facts existing as of the inception date or renewal date of the Business Auto Coverage Form, the coverage afforded by this policy will not be prejudiced.

However, you must report the undisclosed hazard of exposure as soon as practicable after its discovery, and we have the right to collect additional premium for any such hazard or exposure.

20. AMENDED DUTIES IN THE EVENT OF ACCIDENT, CLAIM, SUIT OR LOSS

SECTION IV - BUSINESS AUTO CONDITIONS, Paragraph **A.2.a.** is replaced in its entirety by the following:

- a. In the event of "accident", claim, "suit" or "loss", you must promptly notify us when it is known to:
 - (1) You, if you are an individual;
 - (2) A partner, if you are a partnership;
 - (3) Member, if you are a limited liability company;
 - (4) An executive officer or the "employee" designated by the Named Insured to give such notice, if you are a corporation.

To the extent possible, notice to us should include:

- (a) How, when and where the "accident" or "loss" took place;
- (b) The "insured's" name and address; and
- (c) The names and addresses of any injured persons and witnesses.

21. WAIVER OF TRANSFER OF RIGHTS OF RECOVERY AGAINST OTHERS TO US

SECTION IV - BUSINESS AUTO CONDITIONS, Paragraph **A.5. Transfer Of Rights Of Recovery Against Others To Us**, is amended by the addition of the following:

If the person or organization has in a written agreement waived those rights before an "accident" or "loss", our rights are waived also.

22. HIRED AUTO COVERAGE TERRITORY

SECTION IV - BUSINESS AUTO CONDITIONS, Paragraph **B.7. Policy Period, Coverage Territory**, is amended by the addition of the following:

- f. For "autos" hired 30 days or less, the coverage territory is anywhere in the world, provided that the "insured's" responsibility to pay for damages is determined in a "suit", on the merits, in the United States, the territories and possessions of the United States of America, Puerto Rico or Canada or in a settlement we agree to.



280

er 88

81

This extension of coverage does not apply to an "auto" hired, leased, rented or borrowed with a driver.

23. PRIMARY AND NON-CONTRIBUTING IF REQUIRED BY WRITTEN CONTRACT OR WRITTEN AGREEMENT

The following is added to **SECTION IV - BUSINESS AUTO CONDITIONS, General Conditions, B.5. Other Insurance** and supersedes any provision to the contrary:

This Coverage Form's Covered Autos Liability Coverage is primary to and will not seek contribution from any other insurance available to an "insured" under your policy provided that:

1. Such "insured" is a Named Insured under such other insurance; and
2. You have agreed in a written contract or written agreement that this insurance would be primary and would not seek contribution from any other insurance available to such "insured".

SECTION V - DEFINITIONS is amended as follows:

24. BODILY INJURY REDEFINED

Under **SECTION V - DEFINITIONS**, Definition C. is replaced by the following:

"Bodily injury" means physical injury, sickness or disease sustained by a person, including mental anguish, mental injury, shock, fright or death resulting from any of these at any time.

of 00

02

INSURED: O'Connell Engineering & Construction, Inc

POLICY #: 907645721

POLICY PERIOD: 11/01/2021

TO 11/01/2022



ENDORSEMENT AGREEMENT
WAIVER OF SUBROGATION
BLANKET BASIS

BROKER COPY

HOME OFFICE
SAN FRANCISCO

ALL EFFECTIVE DATES ARE
AT 12:01 AM PACIFIC
STANDARD TIME OR THE
TIME INDICATED AT
PACIFIC STANDARD TIME

WE HAVE THE RIGHT TO RECOVER OUR PAYMENTS FROM ANYONE
LIABLE FOR AN INJURY COVERED BY THIS POLICY. WE WILL
NOT ENFORCE OUR RIGHT AGAINST THE PERSON OR
ORGANIZATION NAMED IN THE SCHEDULE.

THIS AGREEMENT APPLIES ONLY TO THE EXTENT THAT YOU
PERFORM WORK UNDER A WRITTEN CONTRACT THAT REQUIRES YOU
TO OBTAIN THIS AGREEMENT FROM US.

THE ADDITIONAL PREMIUM FOR THIS ENDORSEMENT SHALL BE
2.00% OF THE TOTAL POLICY PREMIUM.

SCHEDULE

<u>PERSON OR ORGANIZATION</u>	<u>JOB DESCRIPTION</u>
ANY PERSON OR ORGANIZATION FOR WHOM THE NAMED INSURED HAS AGREED BY WRITTEN CONTRACT TO FURNISH THIS WAIVER	BLANKET WAIVER OF SUBROGATION

NOTHING IN THIS ENDORSEMENT CONTAINED SHALL BE HELD TO VARY, ALTER, WAIVE
OR EXTEND ANY OF THE TERMS, CONDITIONS, AGREEMENTS, OR LIMITATIONS OF THIS
POLICY OTHER THAN AS STATED. NOTHING ELSEWHERE IN THIS POLICY SHALL BE
HELD TO VARY, ALTER, WAIVE OR LIMIT THE TERMS, CONDITIONS, AGREEMENTS OR
LIMITATIONS OF THIS ENDORSEMENT.

COUNTERSIGNED AND ISSUED AT SAN FRANCISCO: OCTOBER 24, 2014

AUTHORIZED REPRESENTATIVE

PRESIDENT AND CEO